

US Mounted Shooting

Pattern Book



USMS SYMBOLS AND DEFINITIONS



Rundown barrel is solid

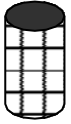

Random barrel is checkered



Light Target



Dark Target

Short target on a short stick will be labeled "Short"



TOB – Target on top of Barrel – May be shot coming into or leaving the turn



Target must be engaged first



Target must be engaged last

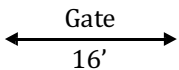

Must pass between these two objects from either direction



You can round object from either direction

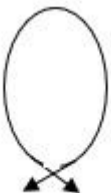

Must make a full turn around the barrel from either direction crossing your path

USMS PROCEDURAL DEFINITIONS

1. Failure to round the random barrel or the rundown barrel
2. Failure to go through the gate
3. Failure to follow the prescribed pattern
4. Failure to engage targets in proper order
 - a. Example – Target must be engaged first 1
5. Failure to engage all the correct targets or gates before rounding the random barrel

Notes:

1. Measurements may be adjusted to ensure the safety of all competitors.
2. Standard spacing for a gate is 16 feet.
3. Standard spacing for the rundown is 30 feet. Rundown spacing for rifle patterns maybe extended to 36 feet.
4. Gate targets may be engaged at any time and competitors must pass completely through the gate with forward motion.
5. If the course includes a Rundown barrel, the competitor shall round the Rundown barrel prior to engaging any targets in the Rundown.
6. Shotgun/Rifle patterns: #6, #19, #29, #34, #38, #39, #42, #51, #52, #53, #54, #55, #56, #57, #61, #62, #83, #84, #85, #86

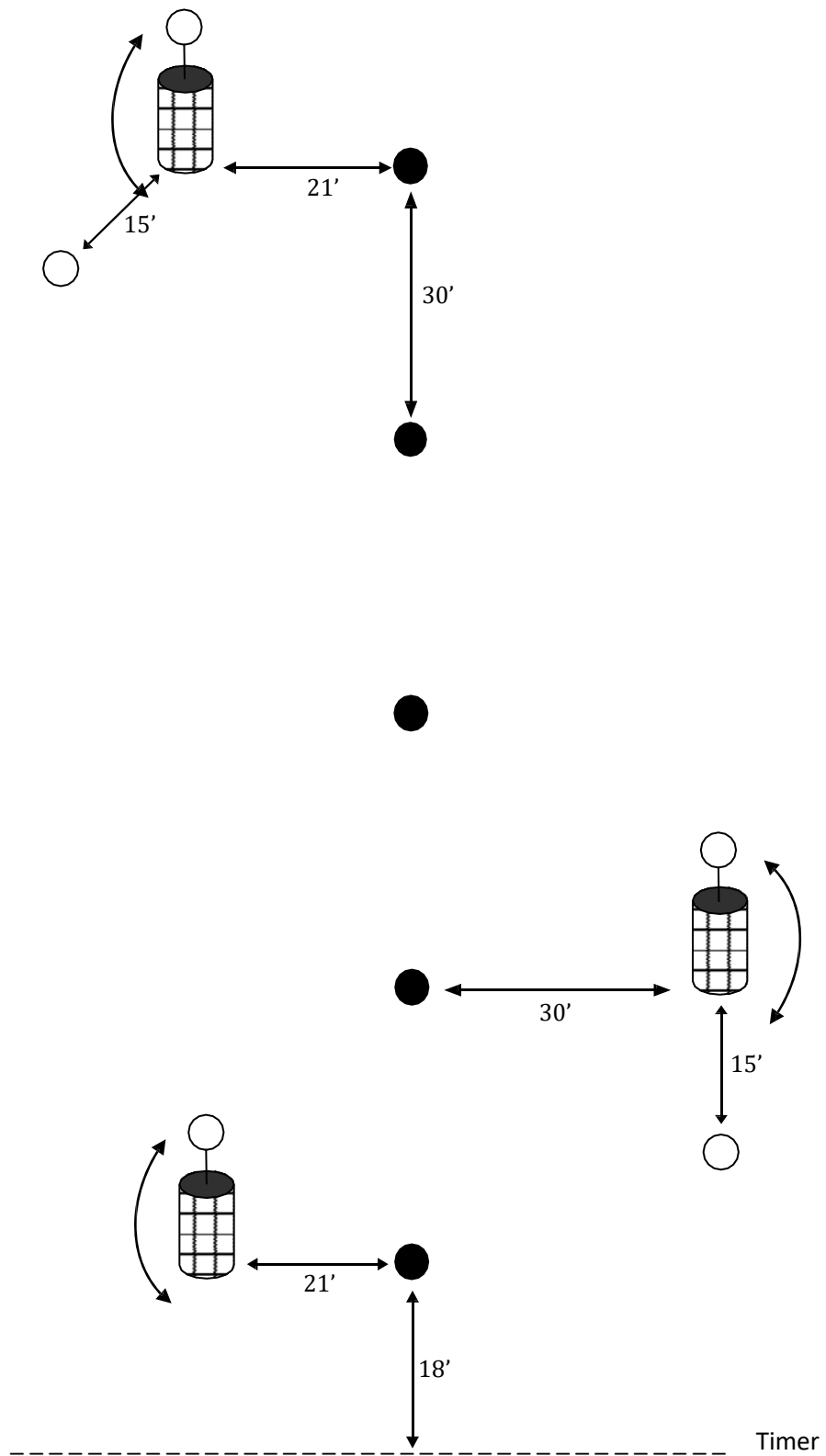

Engage the random course first. Then engage the dark targets.

Procedurals: 1,3

#1

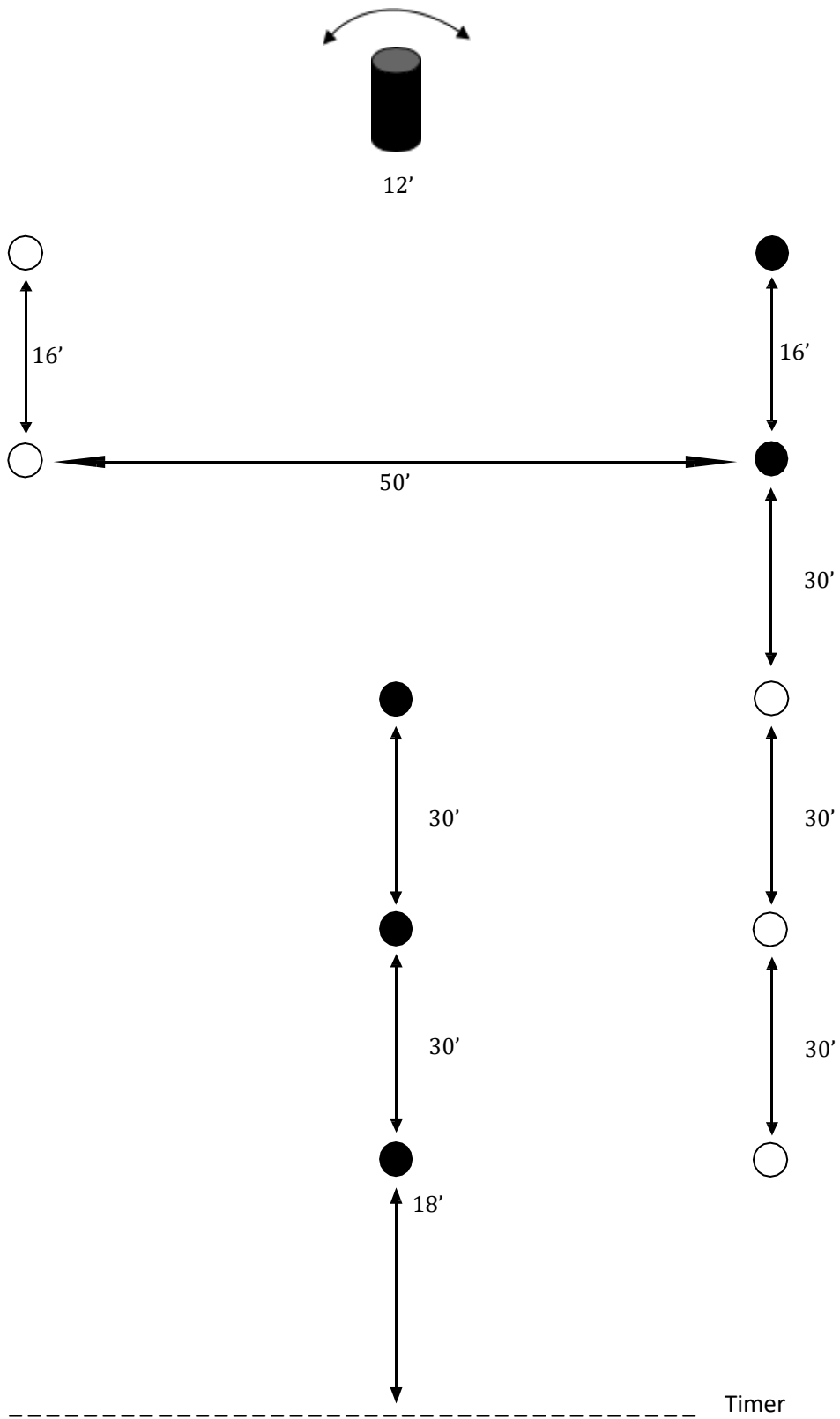

#2 - Certified

Engage all light targets first. Round the Rundown barrel, then engage the dark targets.

Procedurals: 1,3

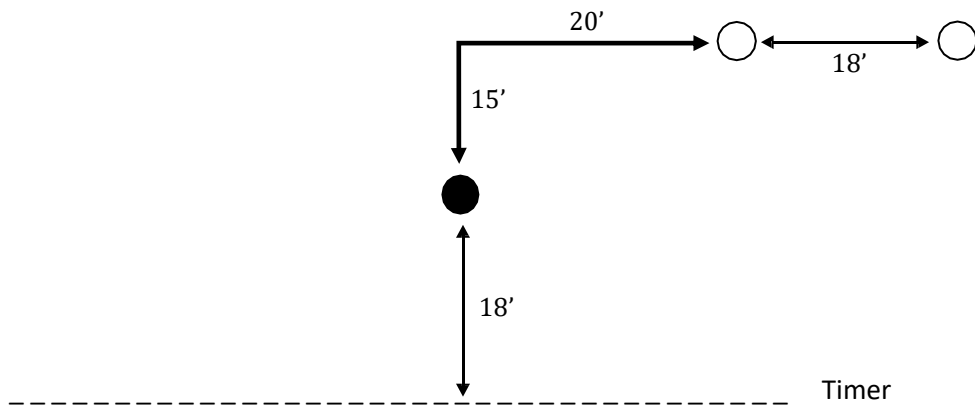
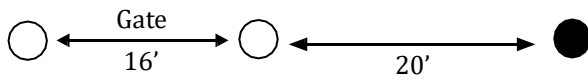
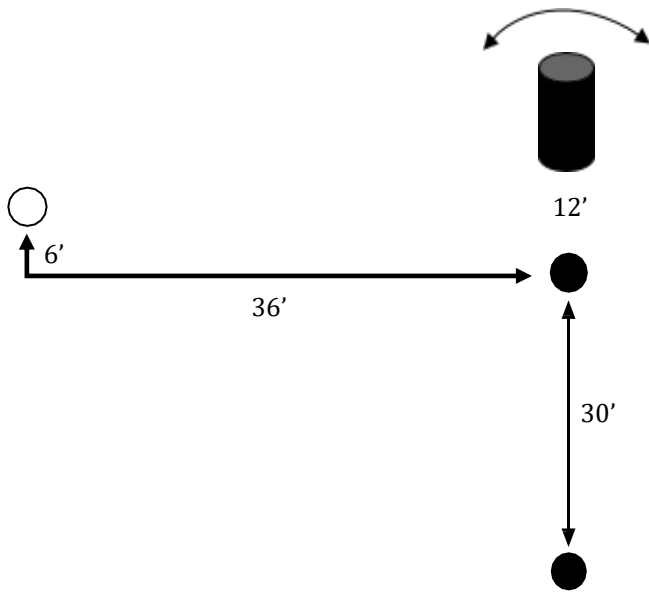

#3 - Certified

Engage all light targets first. Round the Rundown barrel, then engage the dark targets.

Procedurals: 1,2,3

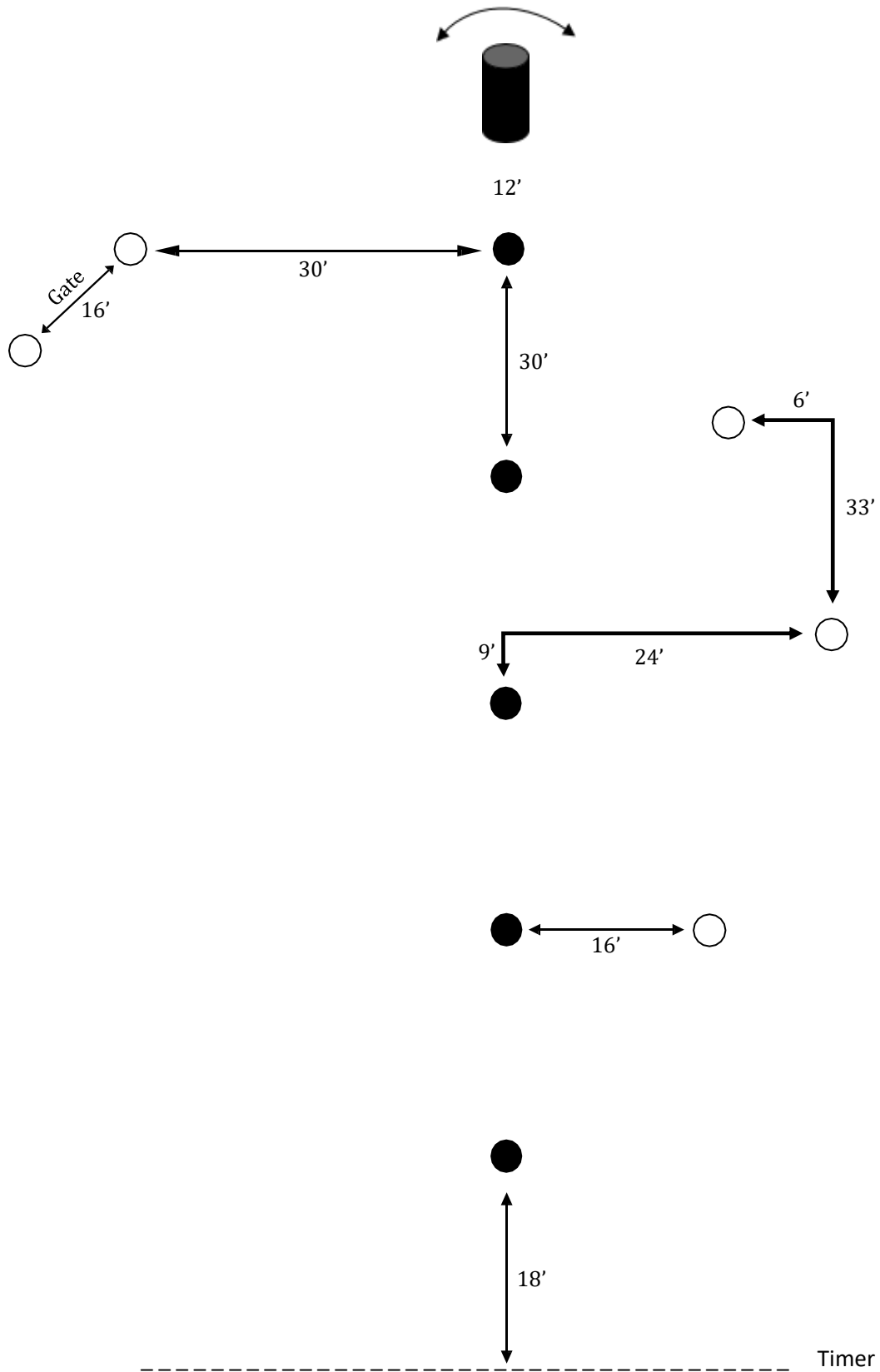

#4

Engage all light targets first. Round the Rundown barrel, then engage the dark targets.

Procedurals: 1,2,3

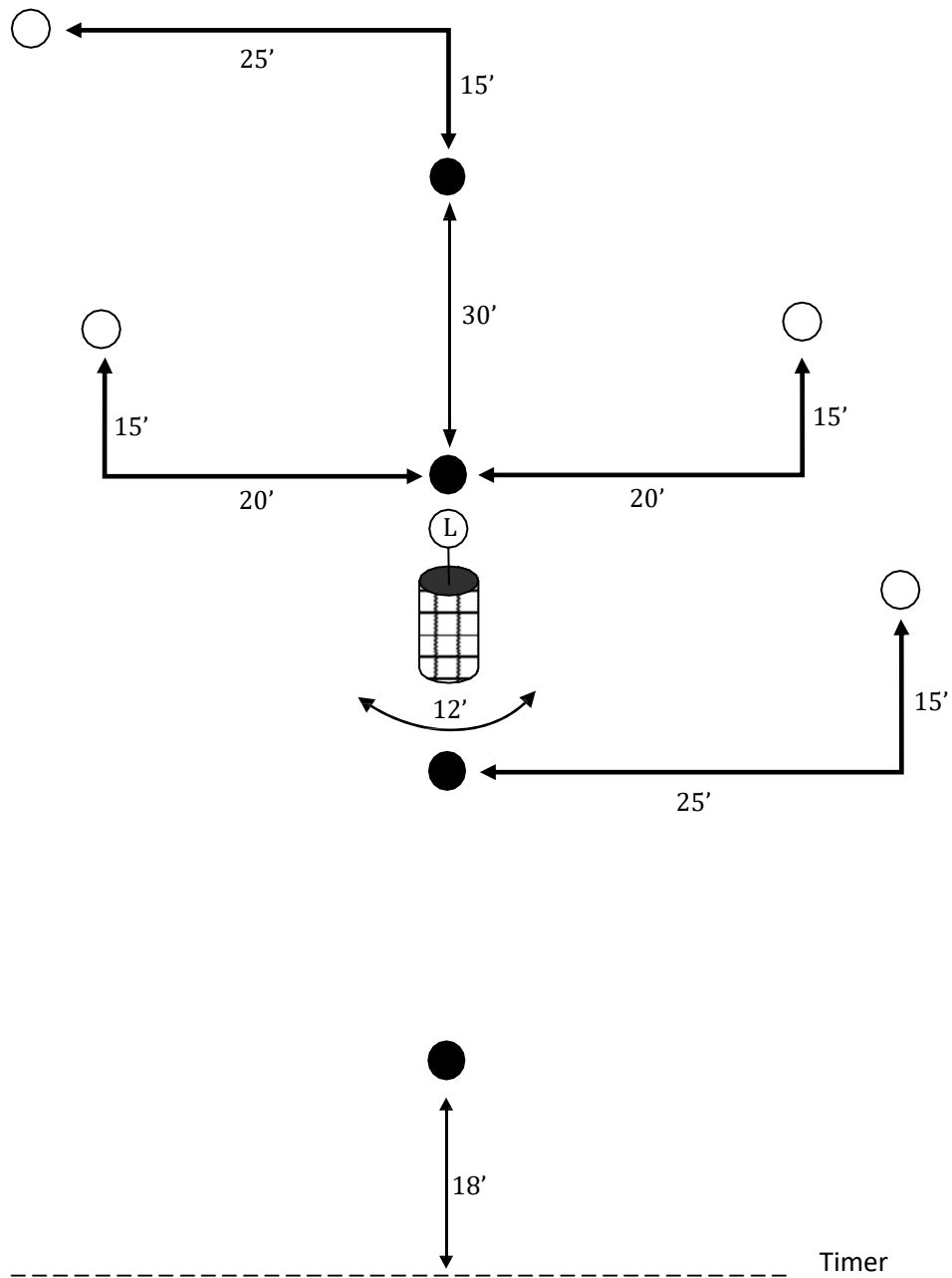
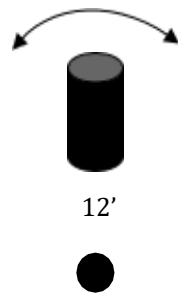

#6

Engage the random course first. Round the Rundown barrel, then engage the dark targets.

Procedurals: 1,3,4,5

Shotgun/Rifle

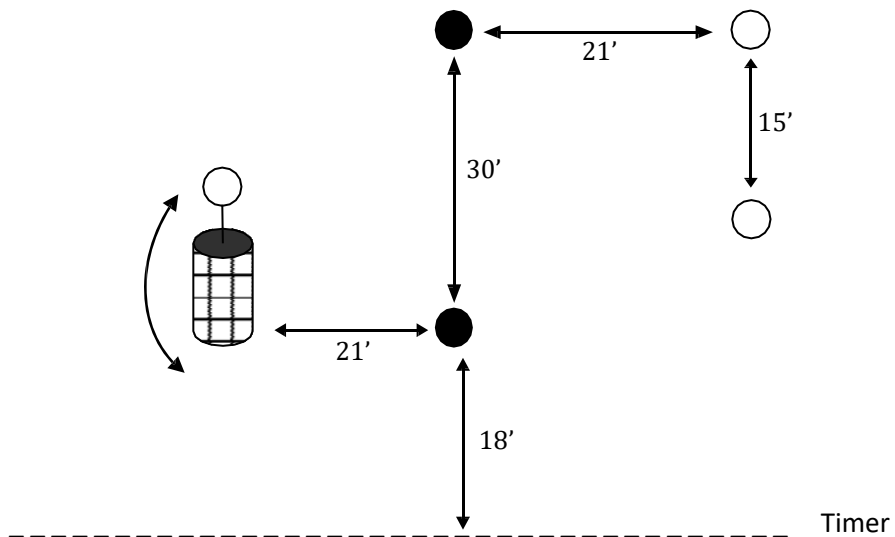
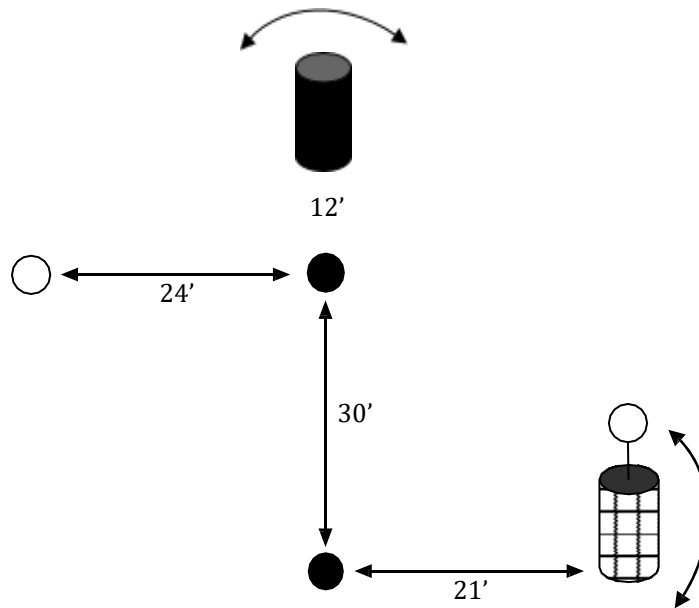

#7

Engage the random course first. Round the Rundown barrel, then engage the dark targets.

Procedurals: 1,3

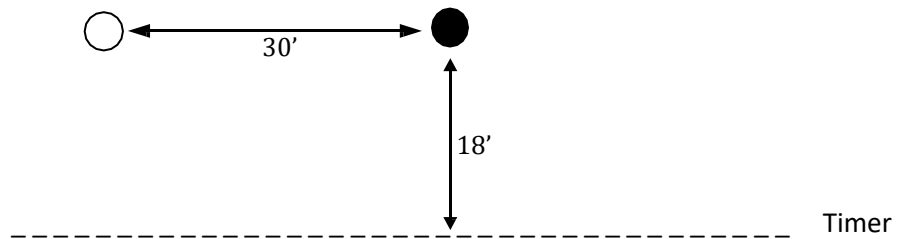
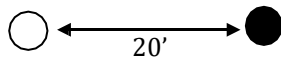
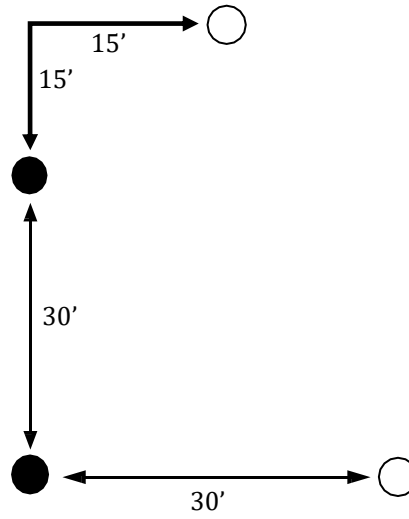
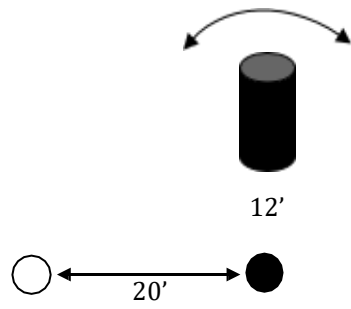

#8 - Certified

Engage all light targets first. Round the Rundown barrel, then engage the dark targets.

Procedurals: 1,3

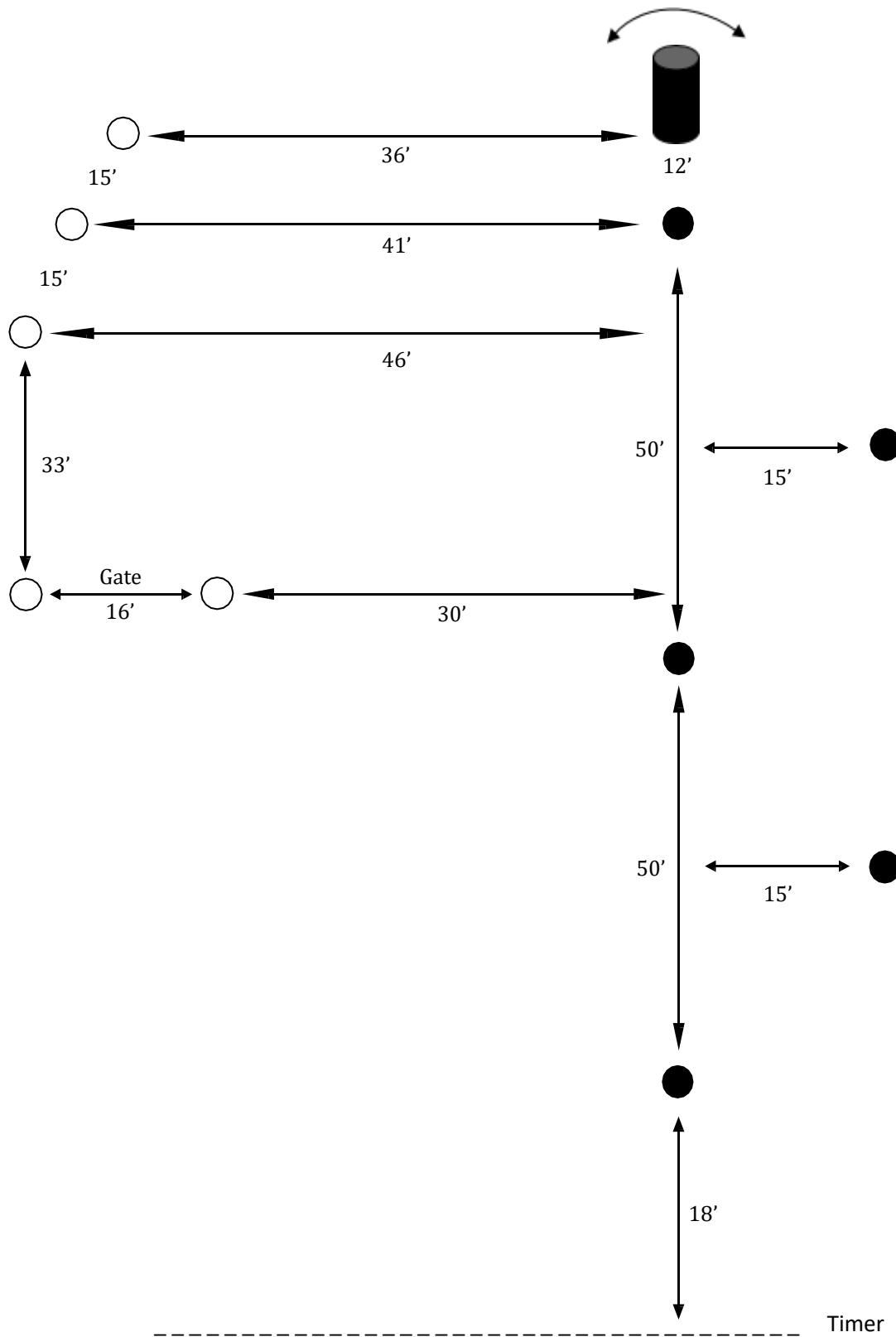

Engage all light targets first. Round the Rundown barrel, then engage the dark targets.

Procedurals: 1,2,3

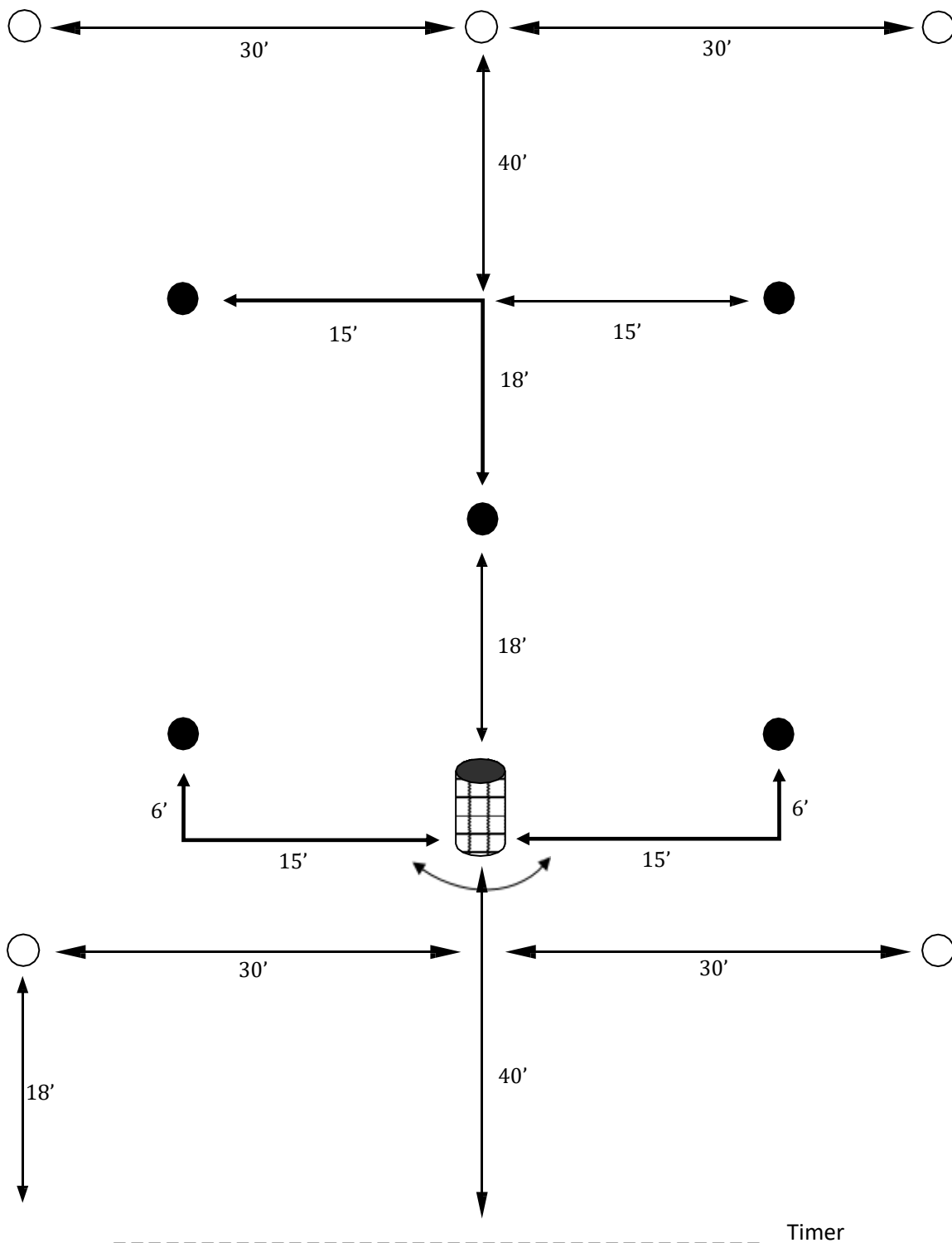

#10

Engage all light targets first, then round the random barrel, then engage all the dark targets.

Procedurals: 1,3,5

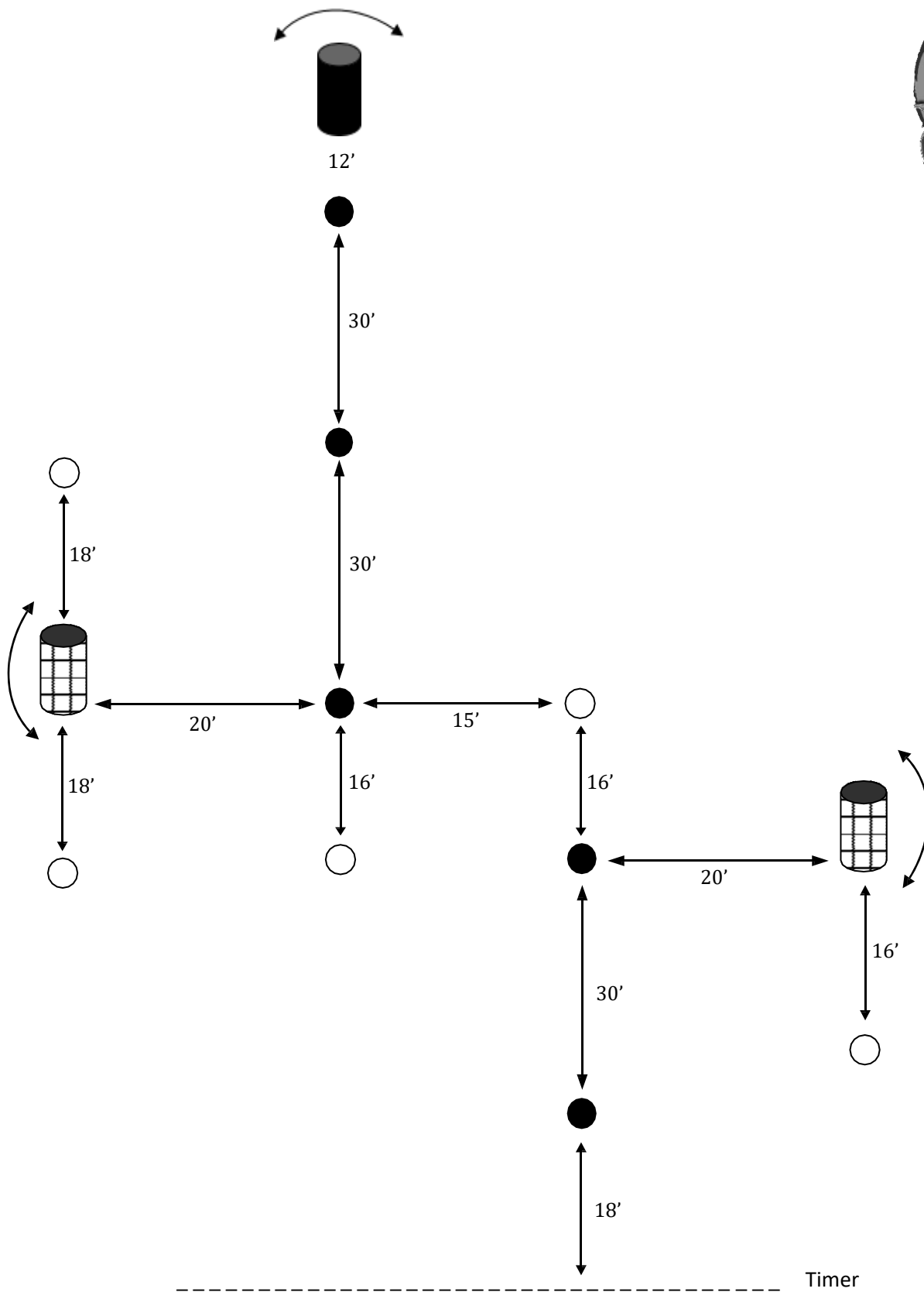

#11

Engage the random course first. Round the Rundown barrel, then engage the dark targets.

Procedurals: 1,3

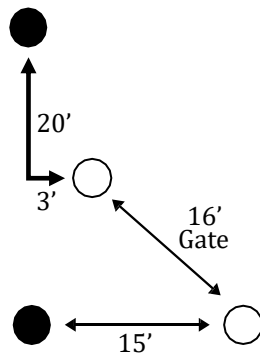
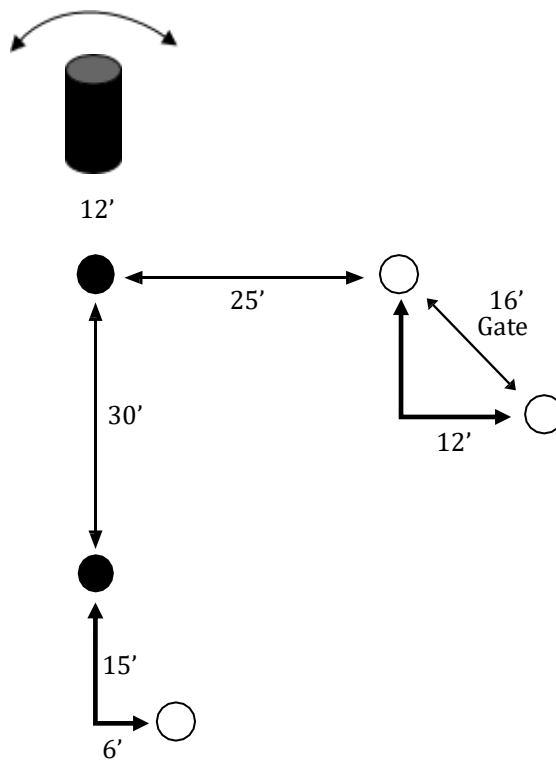

#12 - Certified

Engage all light targets first. Round the Rundown barrel, then engage the dark targets.

Procedurals: 1,2,3

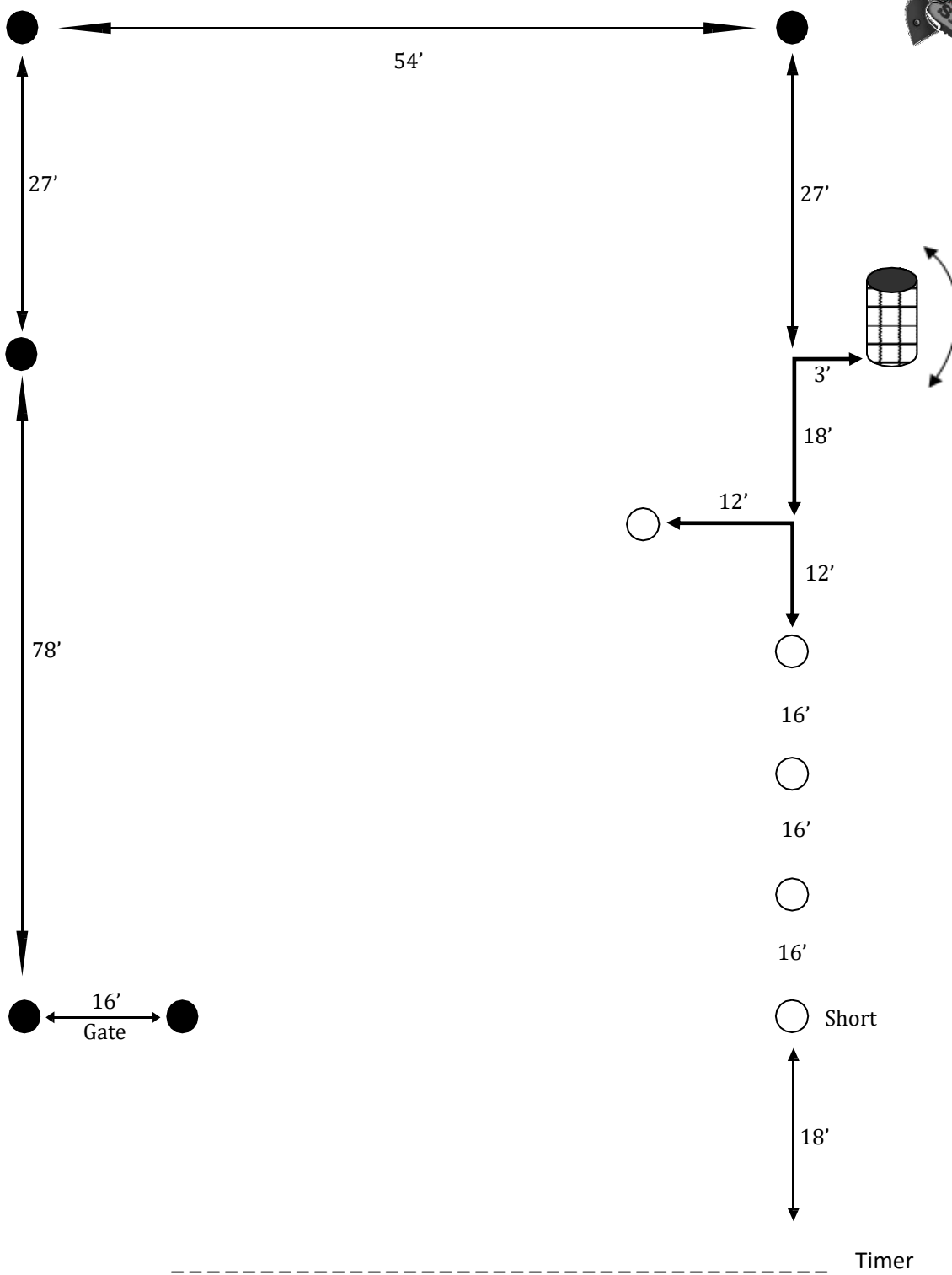

#13

Engage 5 of one color, round the Random barrel, then engage 5 of the other color.

Procedurals: 1,3,5

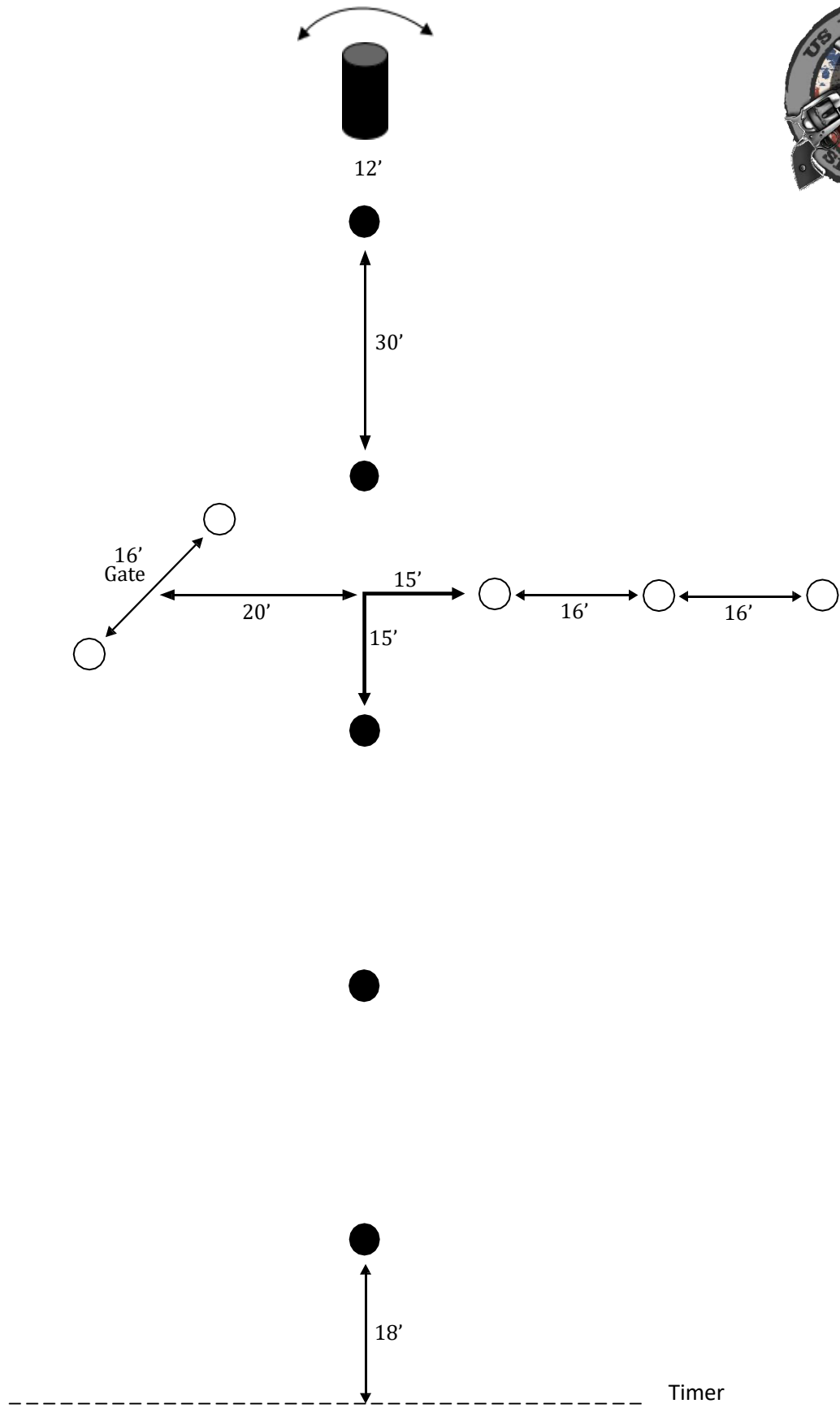

#14

Engage all light targets first. Round the Rundown barrel, then engage the dark targets.

Procedurals: 1,2,3

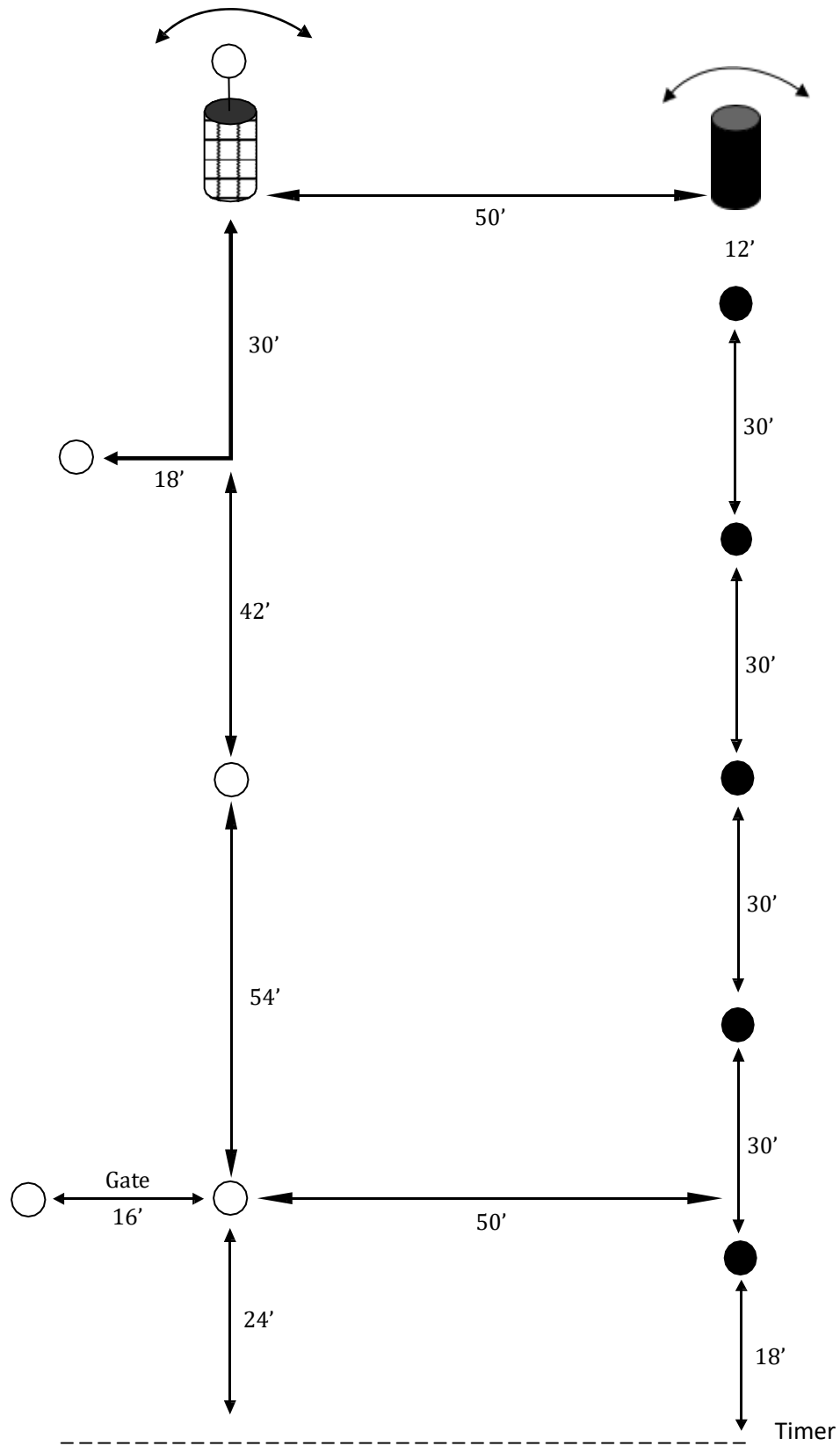

Engage 5 of one color, then engage 5 of the other color.

Procedurals: 1,2,3

#15

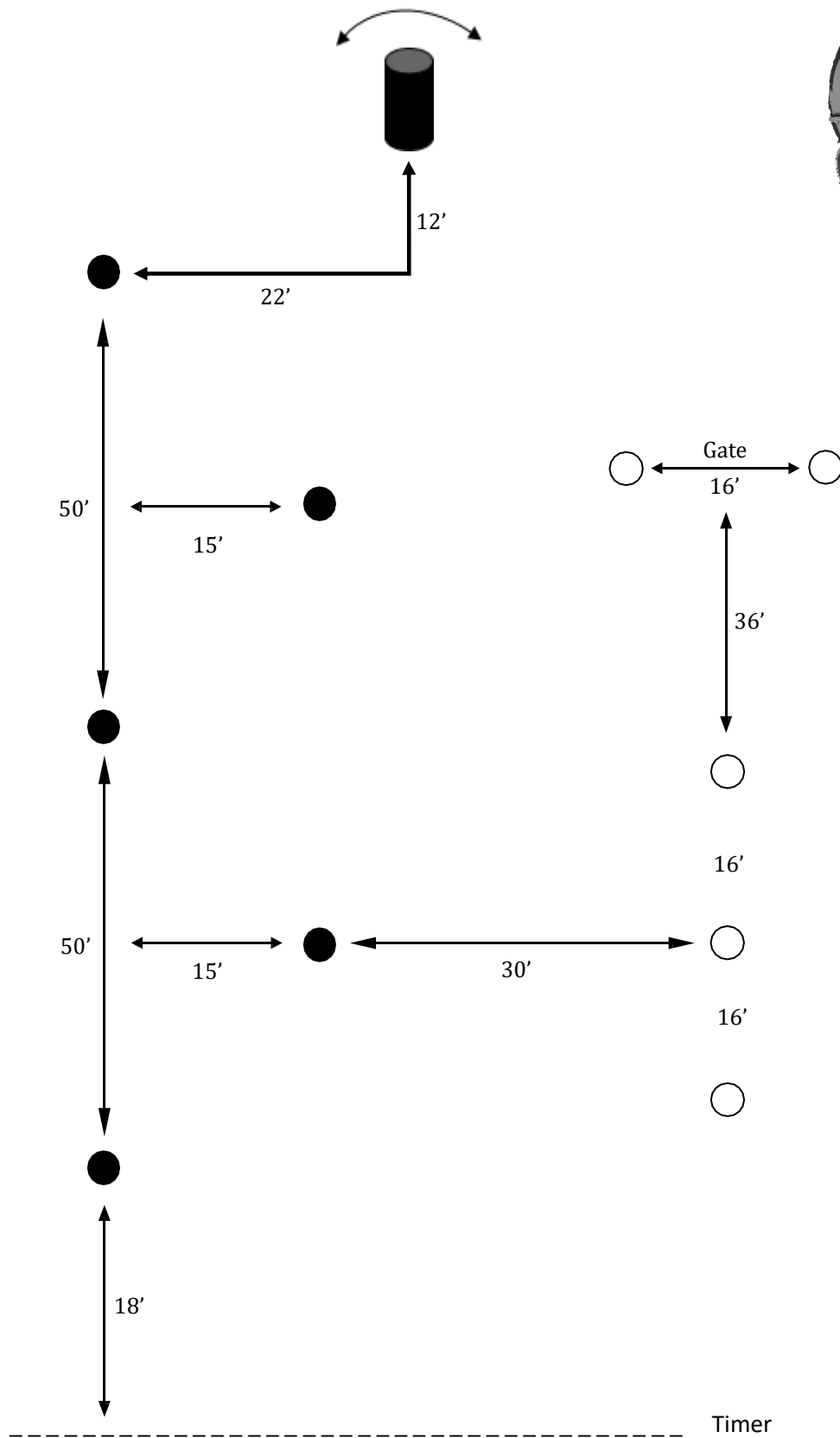

#16

Engage all light targets first. Round the Rundown barrel, then engage the dark targets.

Procedurals: 1,2,3

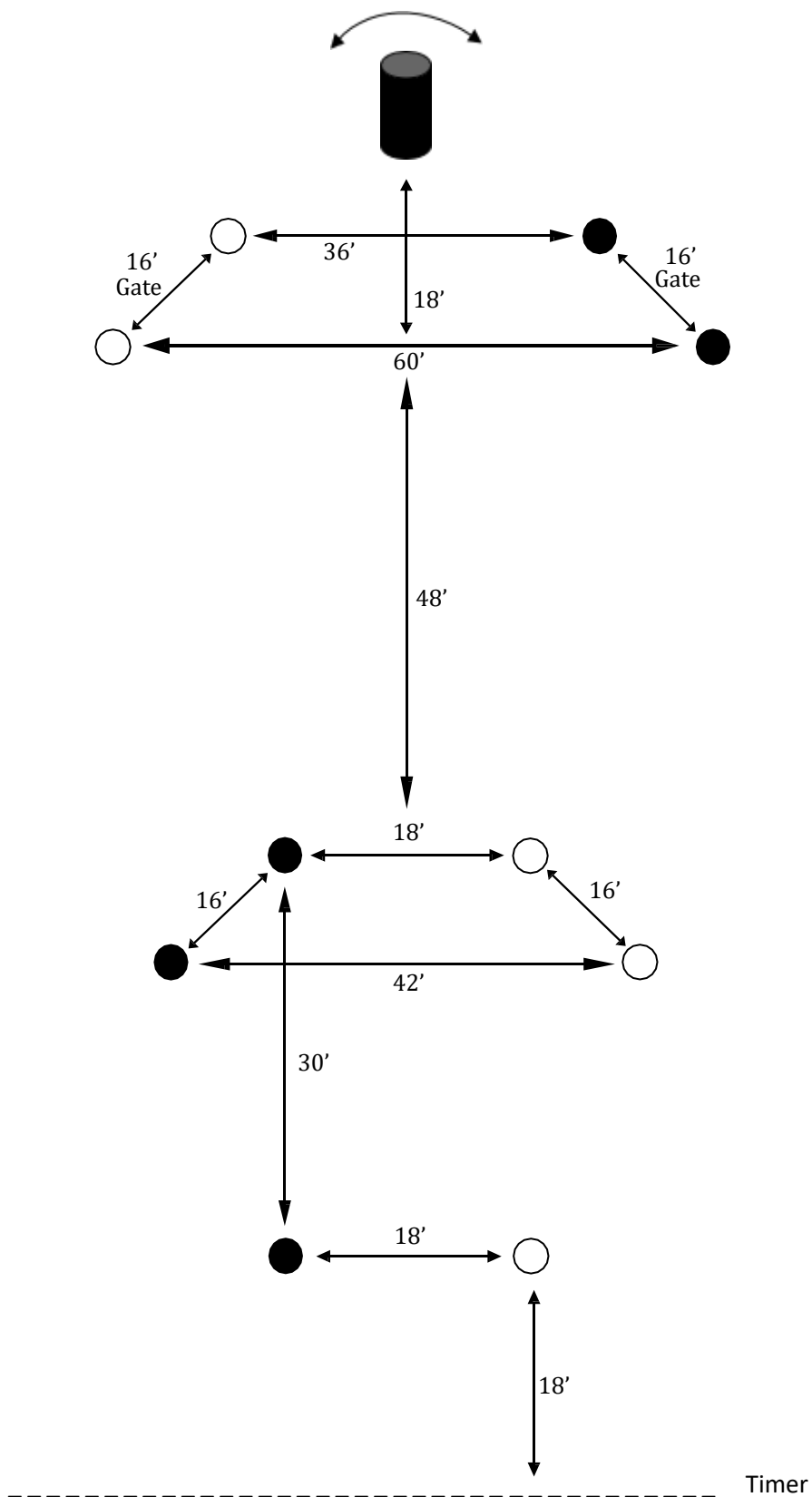

#17 - Certified

Engage 5 of one color, round the Rundown barrel, then engage 5 of the other color.

Procedurals: 1,2,3

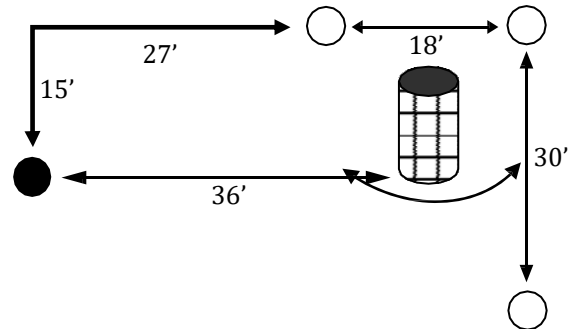
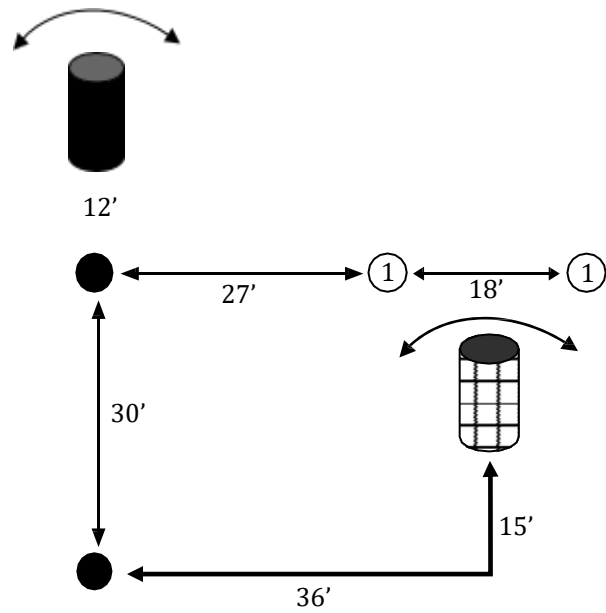

----- Timer

#18

Engage either target 1 first, then engage random course. Round the rundown barrel, then engage the dark targets.

Procedurals: 1,3,4,5

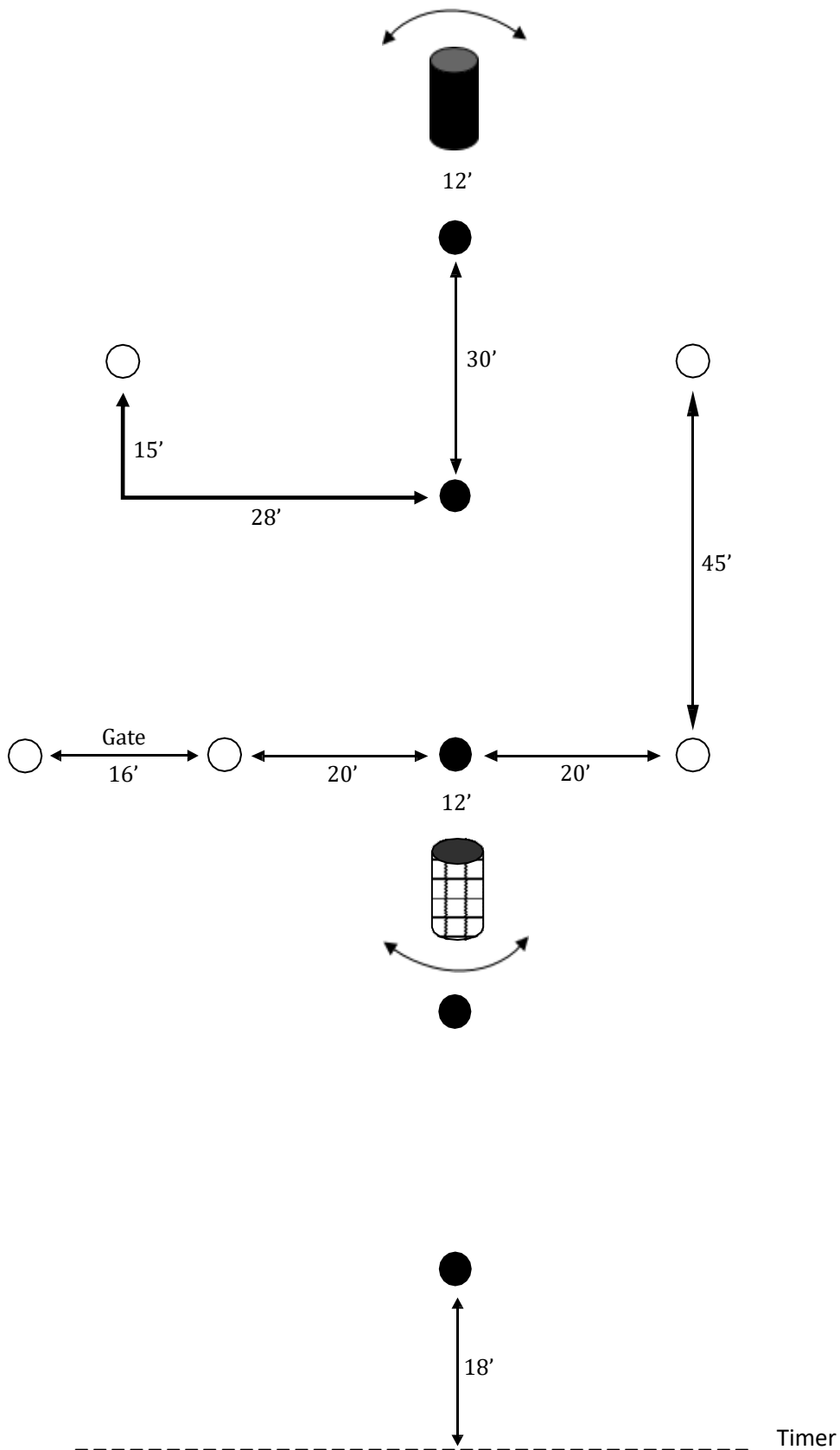

#19

Engage all light targets first, then round the random barrel. Round the Rundown barrel, then engage the dark targets.

Procedurals: 1,2,3,5

Shotgun/Rifle

© 2022

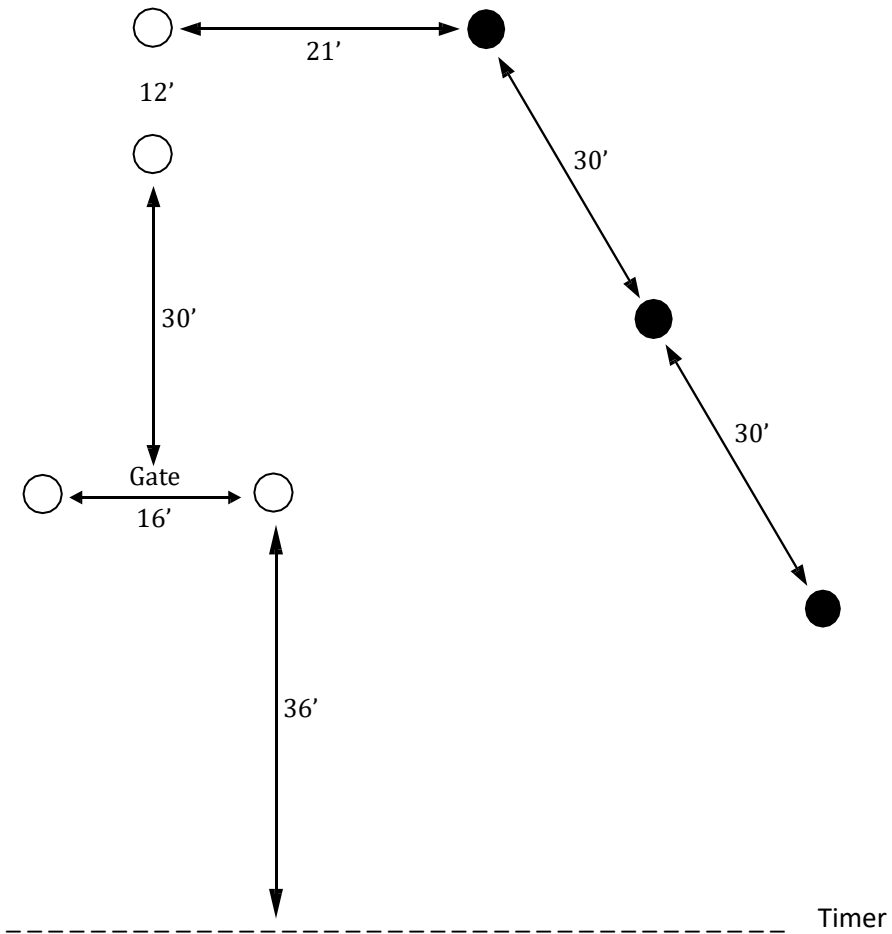
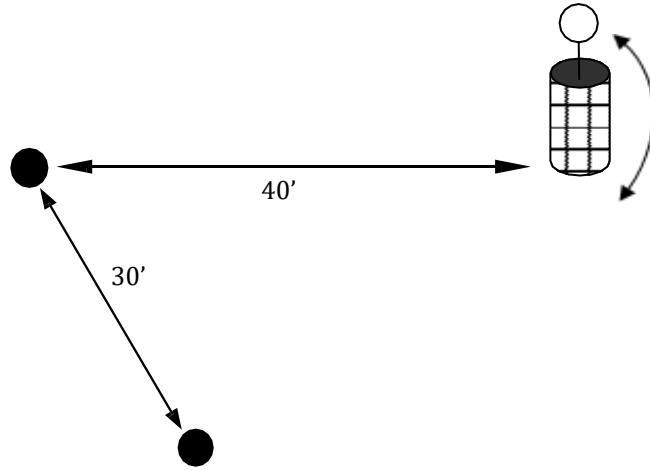

#20

Engage the entire random course first, then engage the dark targets.

Procedurals: 1,2,3,5

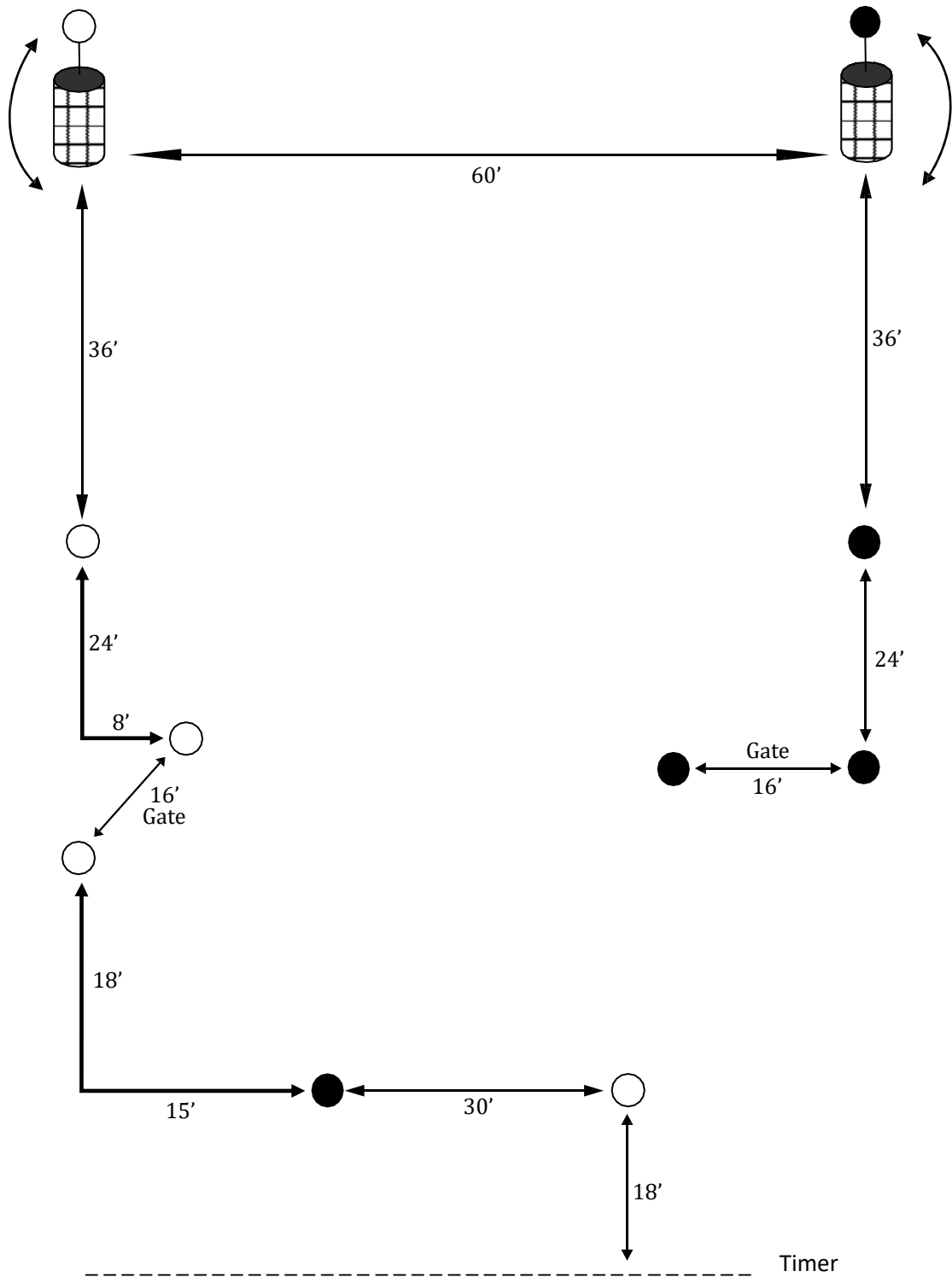

#21

Engage 5 of one color, then engage 5 of the other color.

Procedurals: 1,2,3

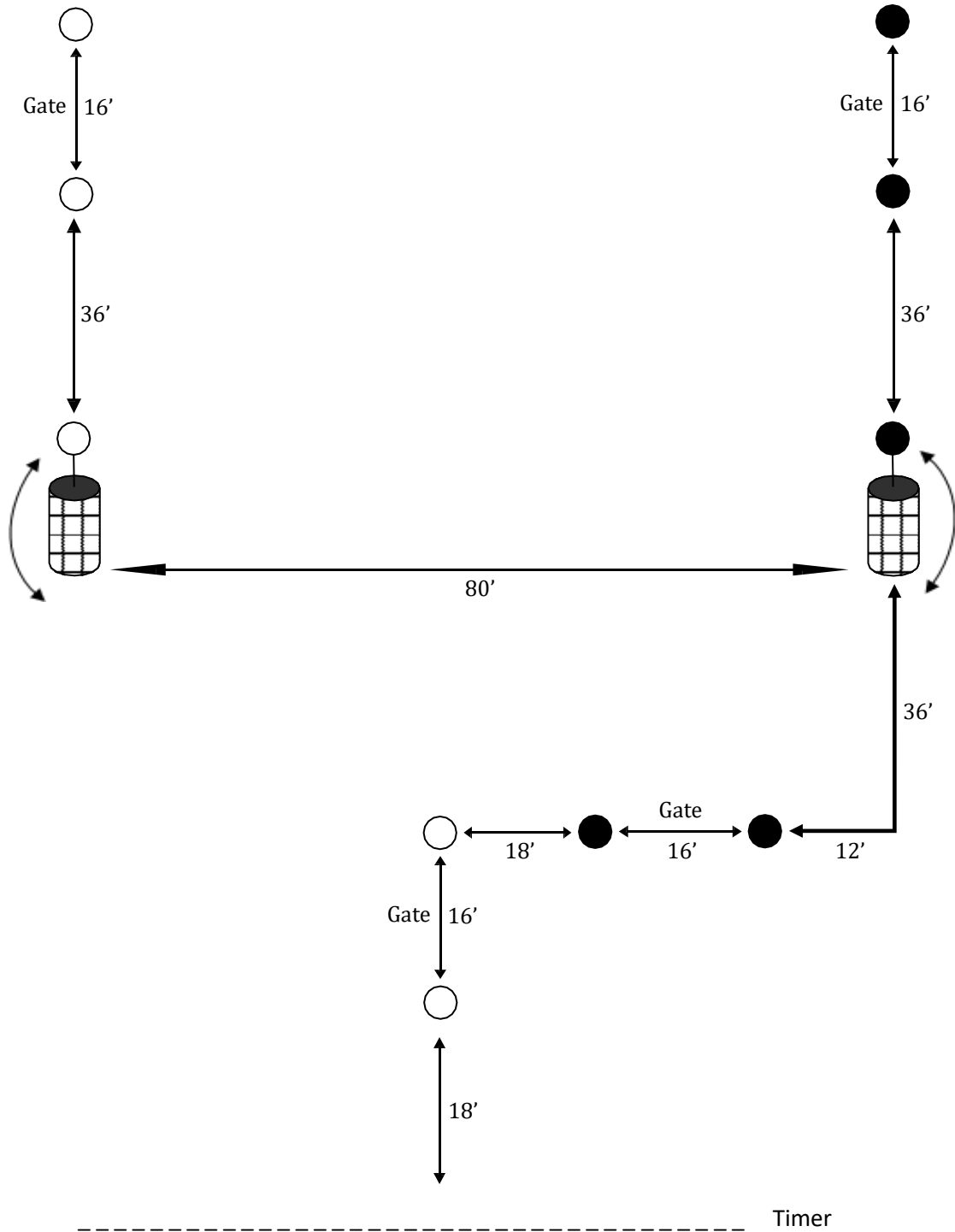

#22

Engage 5 of one color, then engage 5 of the other color.

Procedurals: 1,2,3

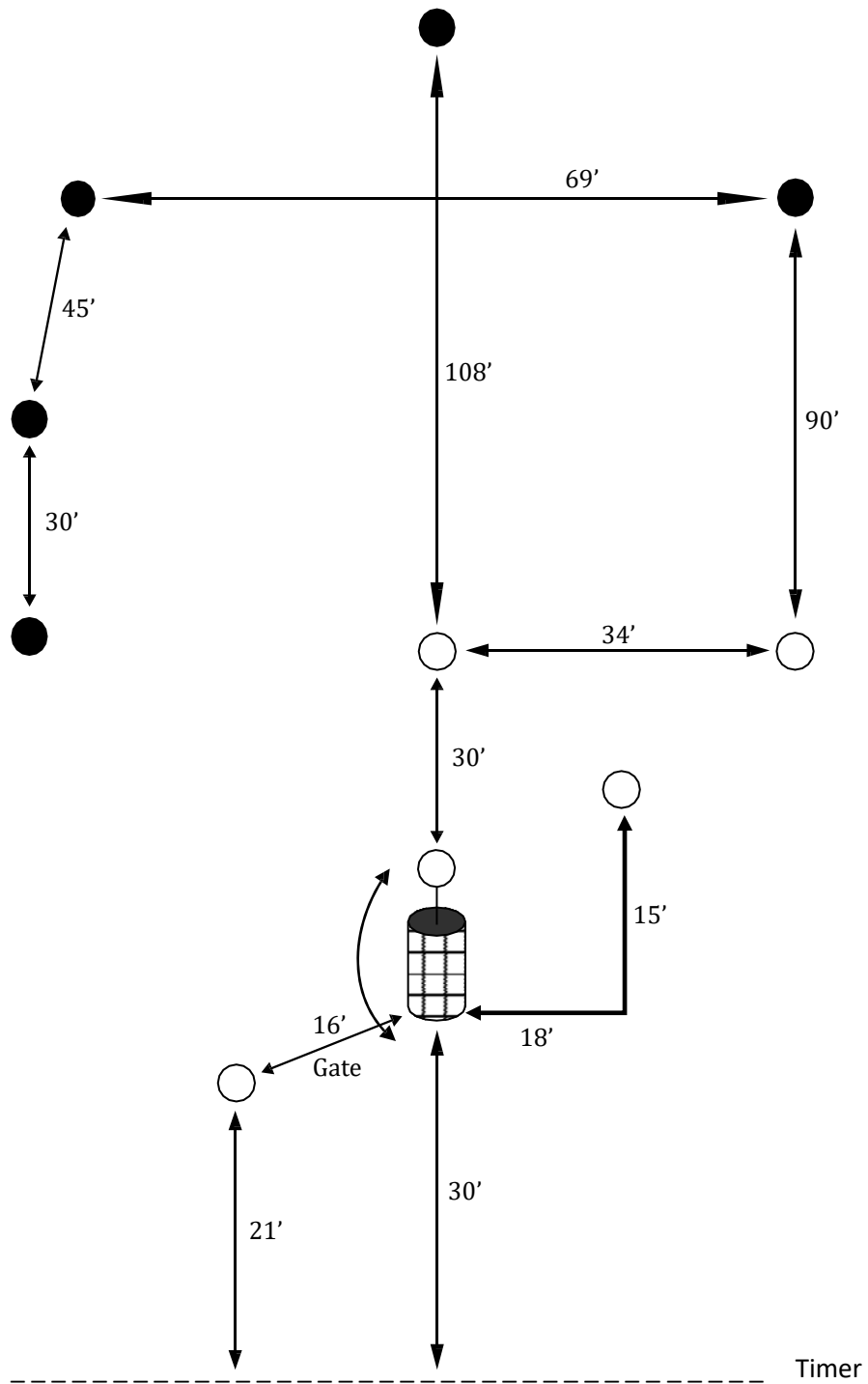

Engage the random course first. Then engage the dark targets.

Procedurals: 1,2,3

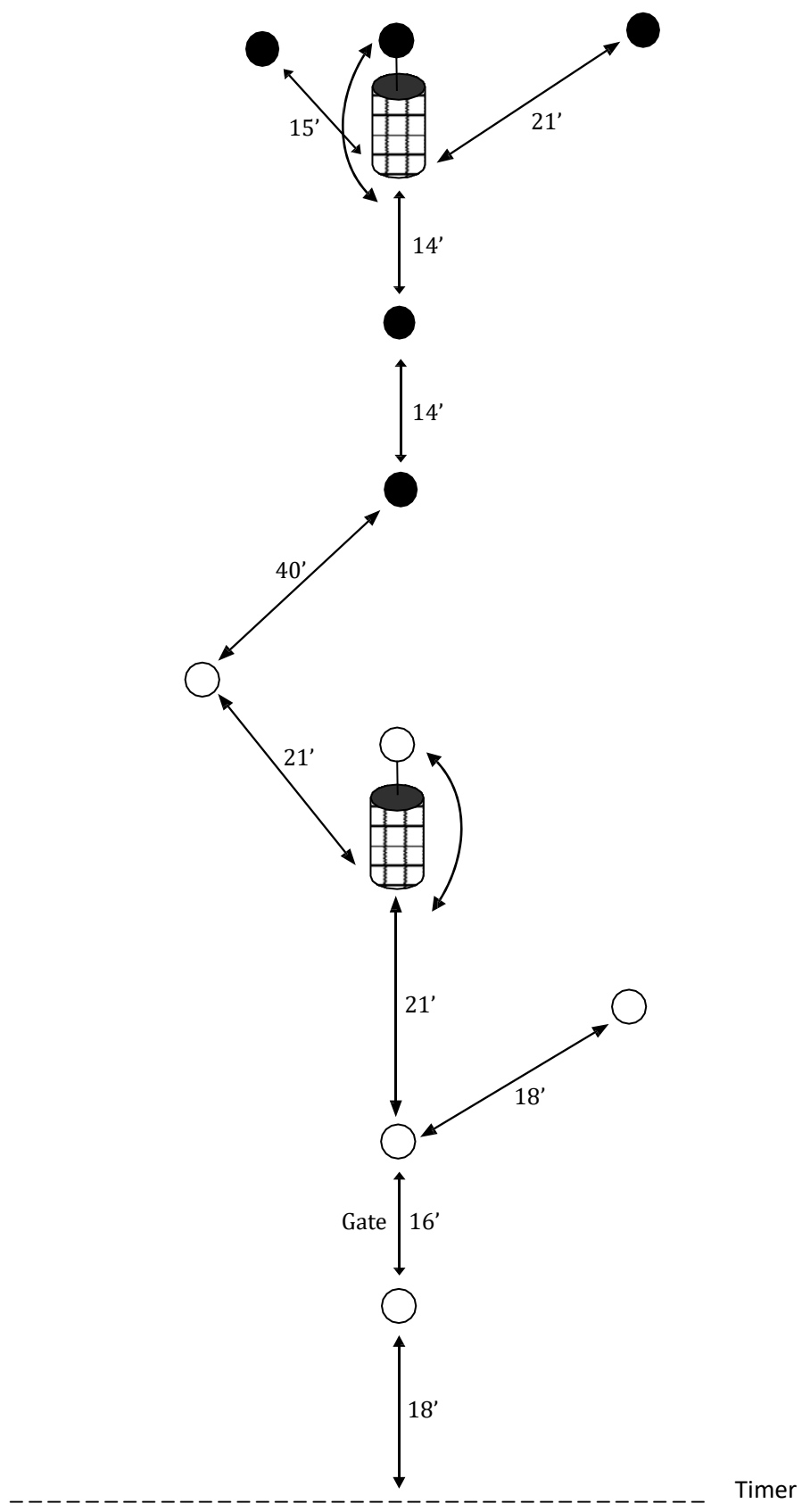

#24

Engage all light targets first, then engage all the dark targets.

Procedurals: 1,2,3

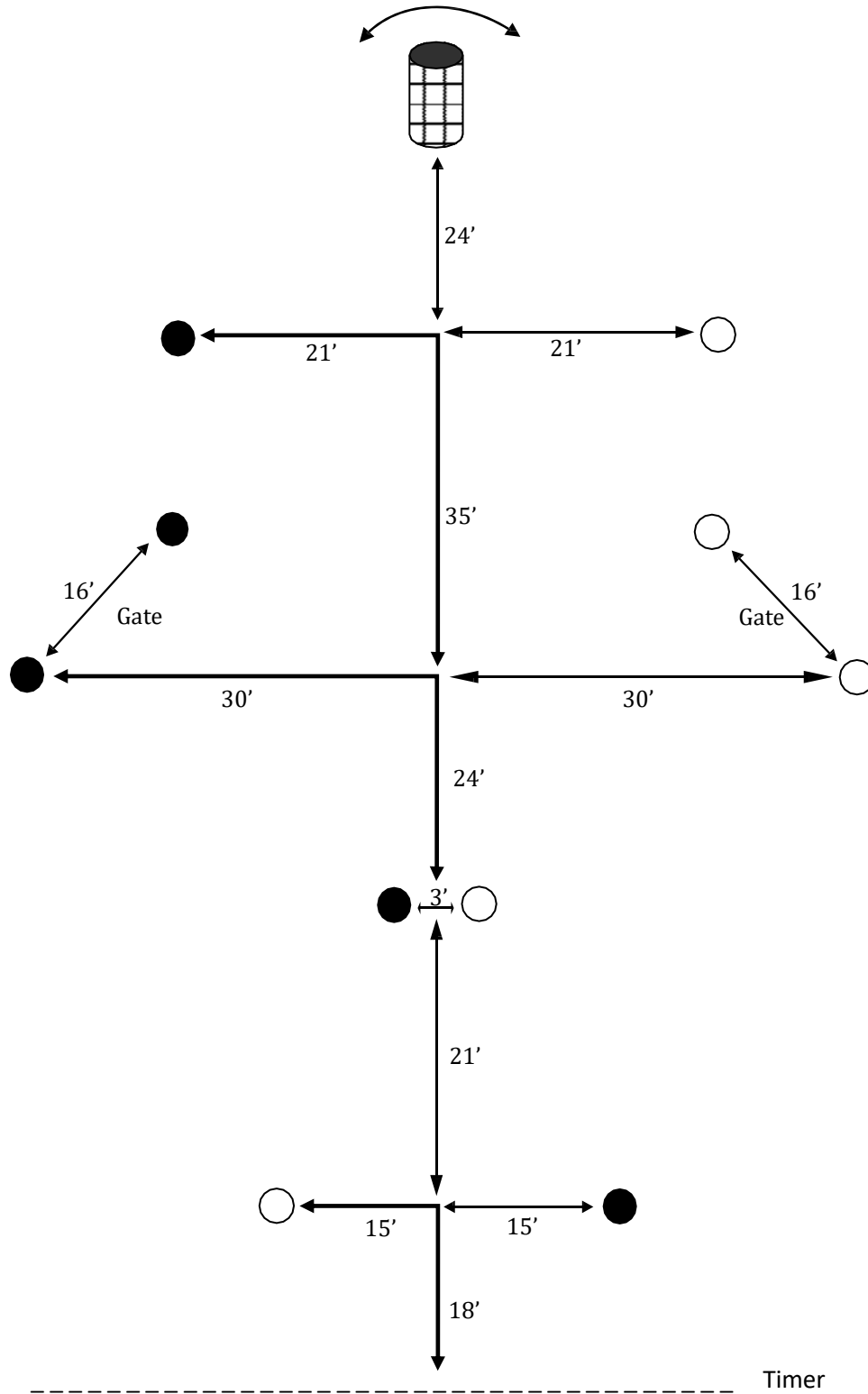

#25

Engage 5 of one color, round random barrel, then engage 5 of the other color.

Procedurals: 1,3,5

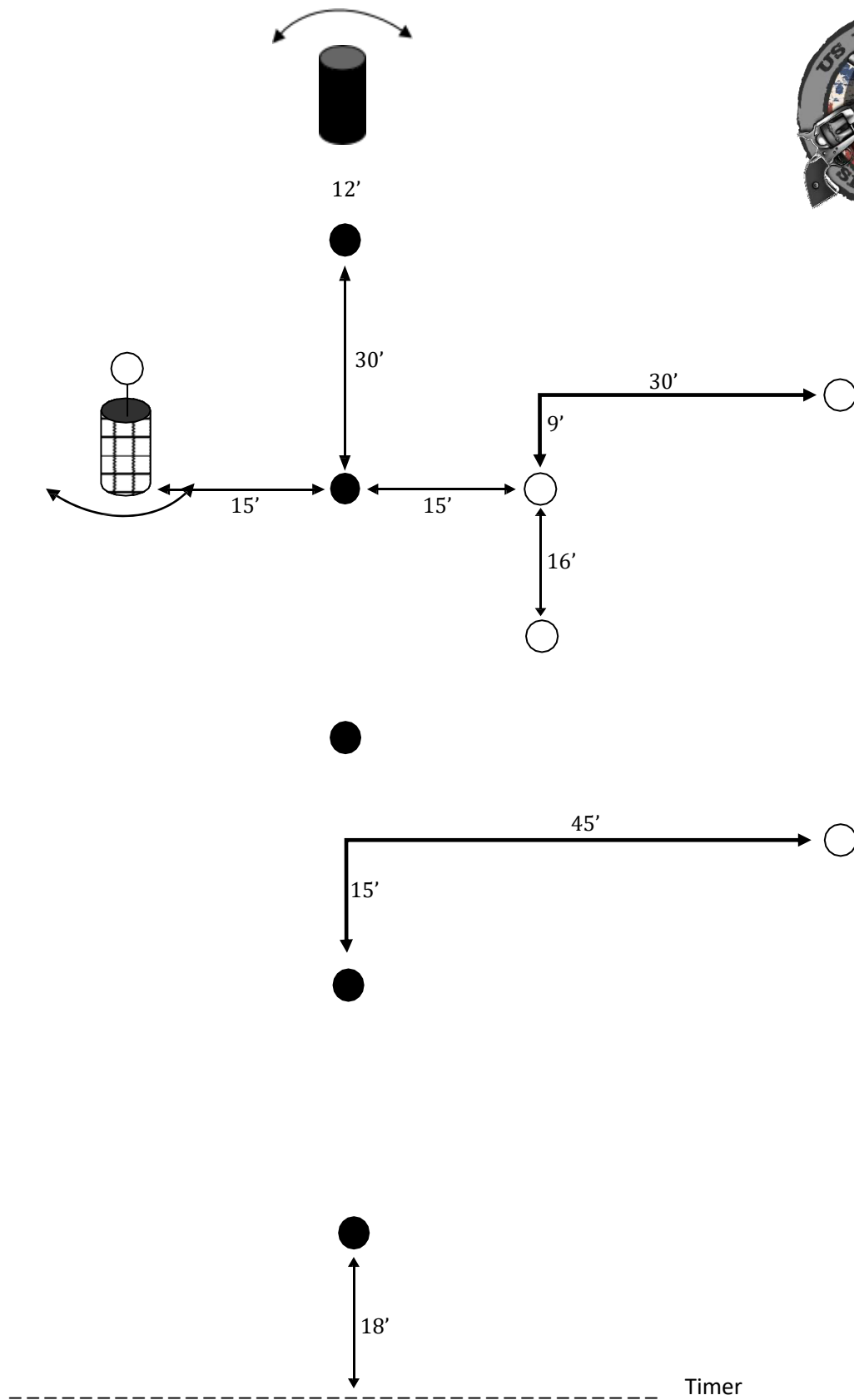

#26

Engage all light targets first, then round the random barrel. Round the Rundown barrel, then engage the dark targets.

Procedurals: 1,3,5

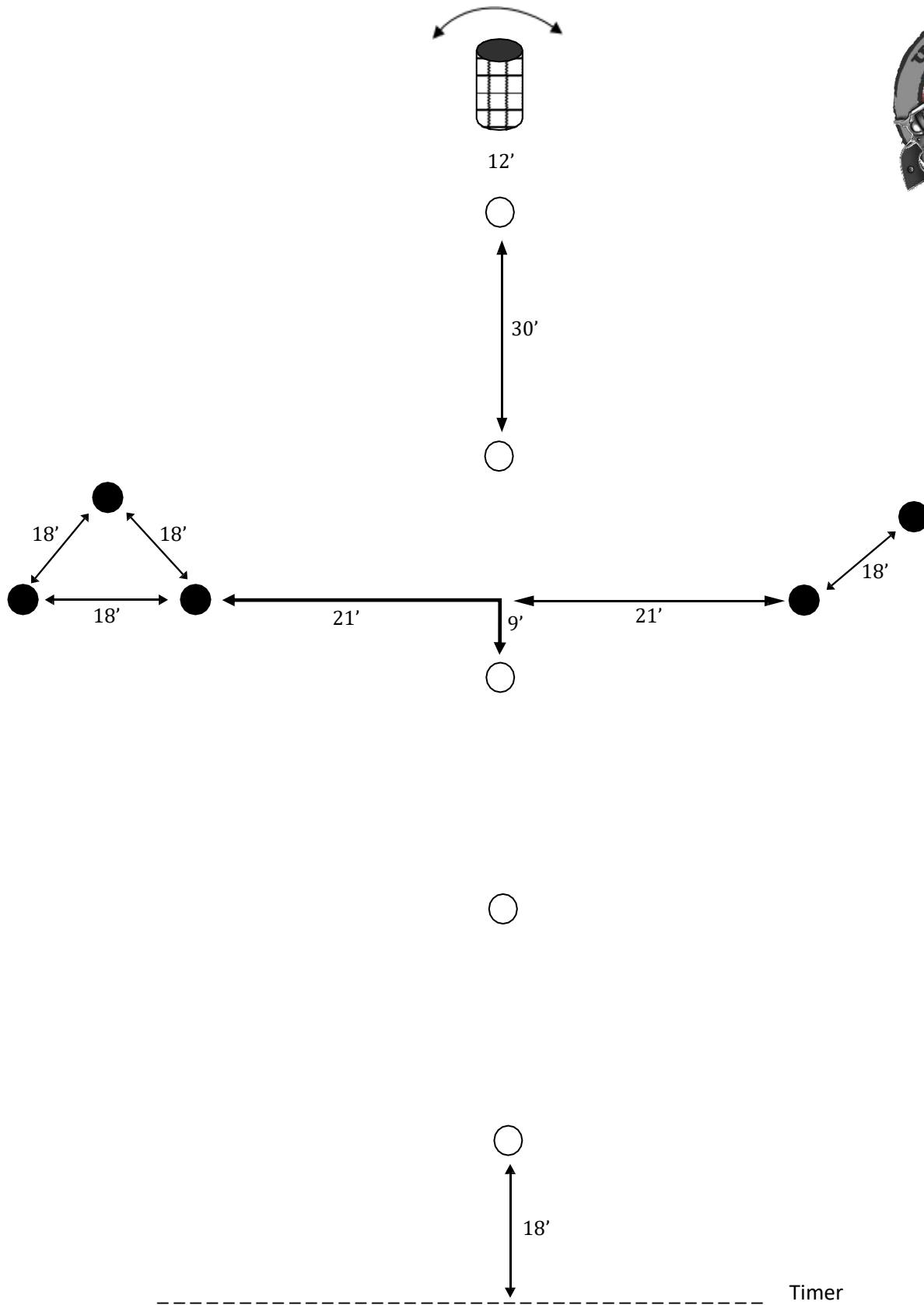

#27

Engage all light targets first, round the Random barrel. Then engage all the dark targets.

Procedurals: 1,3

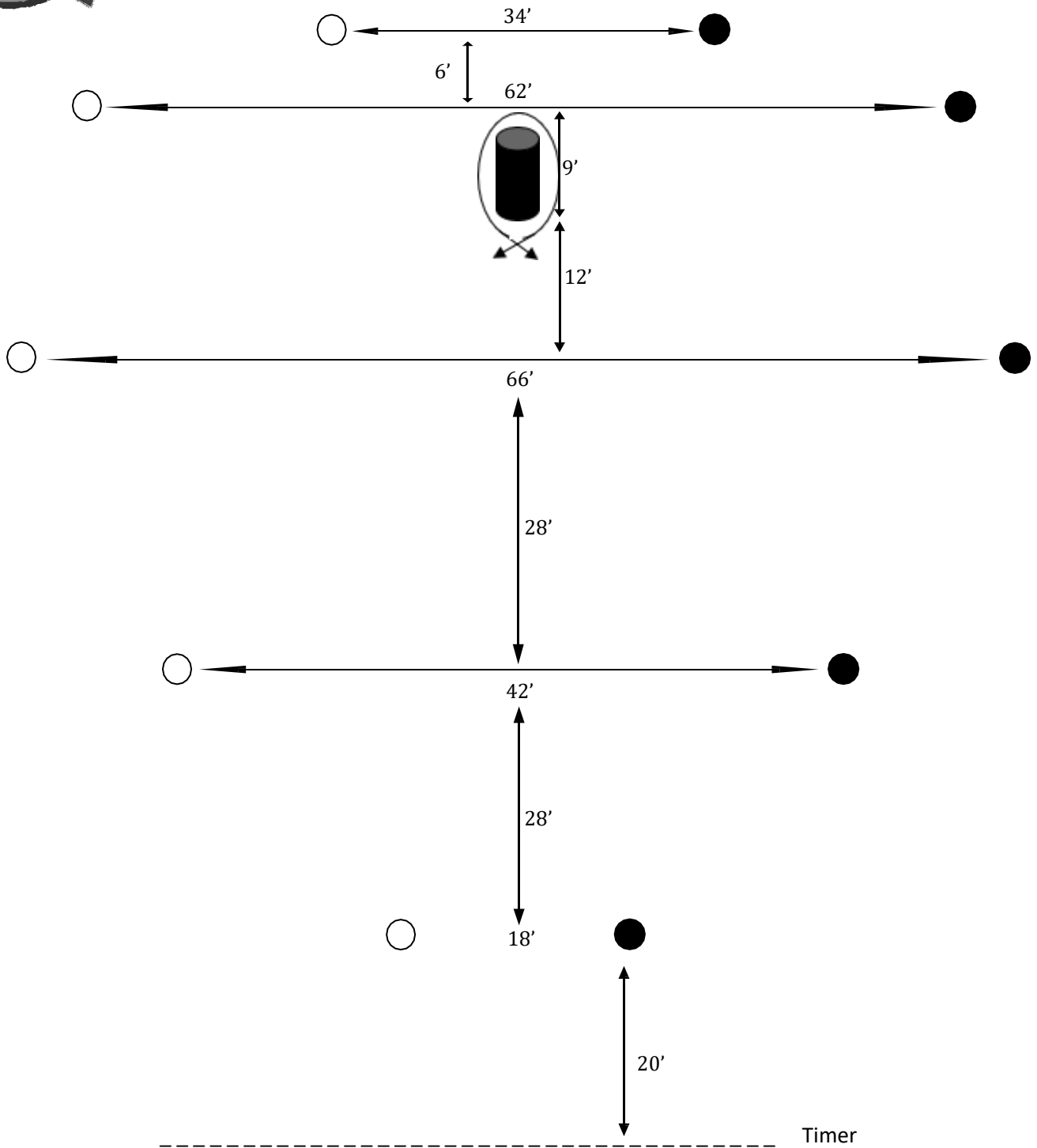

#28

Engage 5 of one color, circle the barrel, then engage 5 of the other color.

Procedurals: 1,3

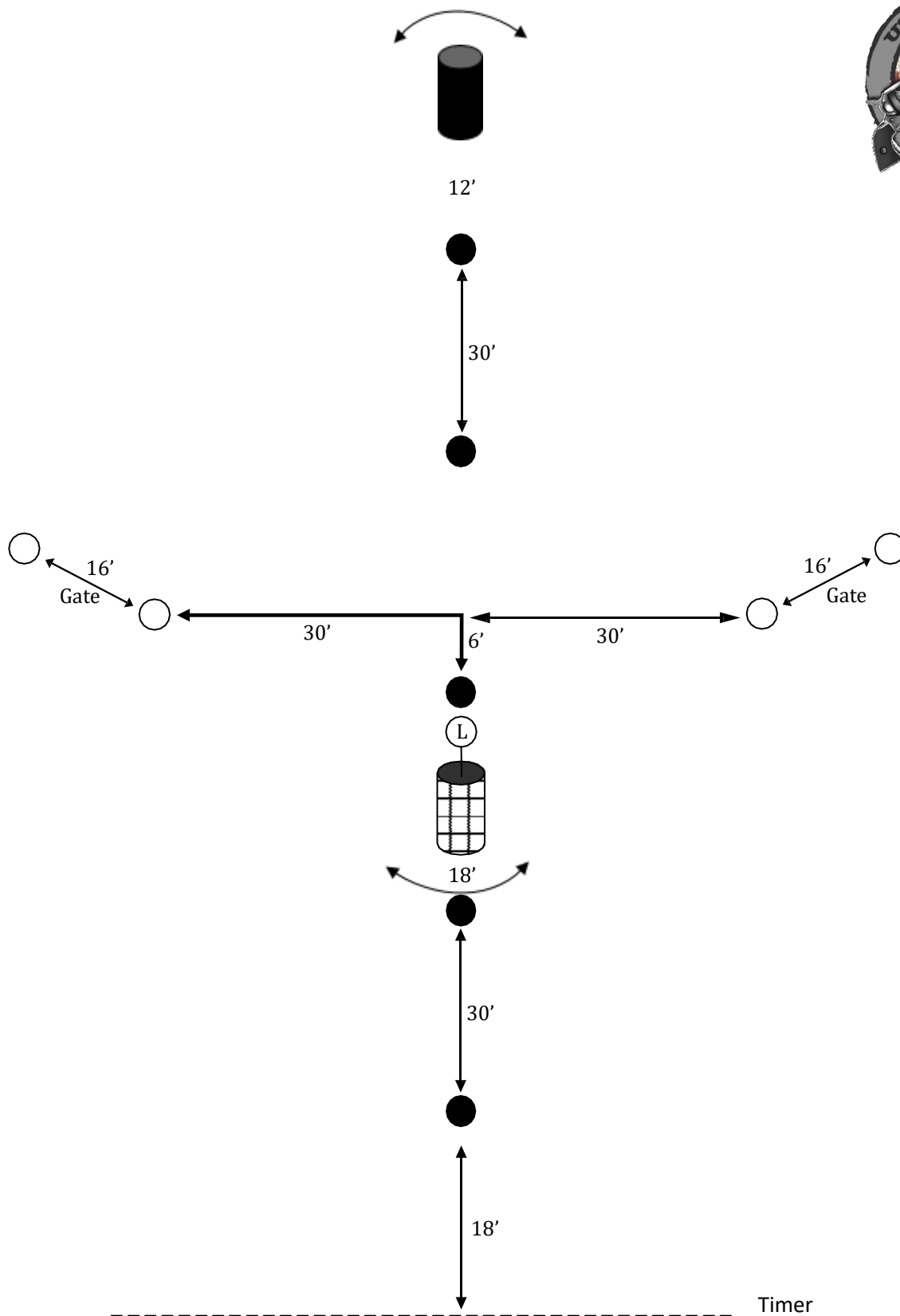

#29

Engage the random course first. Round the Rundown barrel, then engage the dark targets.

Procedurals: 1,2,3,4,5

Shotgun/Rifle

© 2022

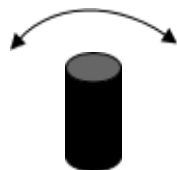

12'

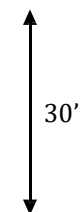

18'

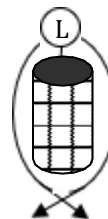
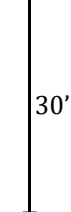

30'

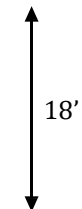
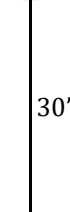

----- Timer

#30

Engage the random course first. Round the Rundown barrel, then engage the dark targets.

Procedurals: 1,4

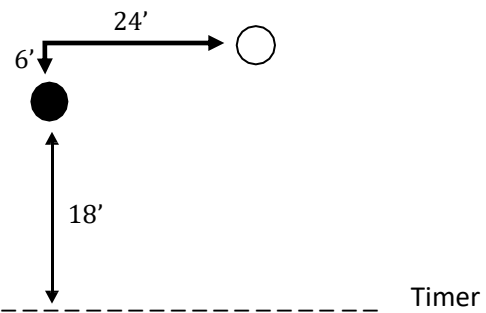
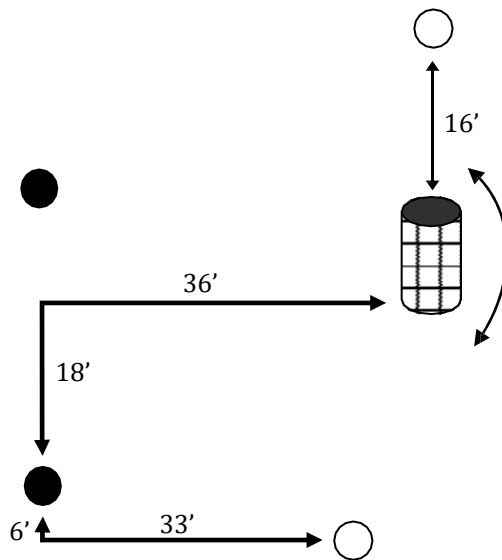
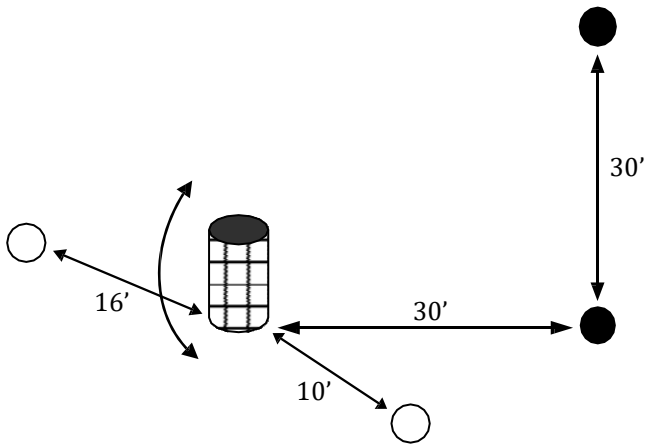

#31

Engage the random course first, then engage the dark targets

Procedurals: 1,3

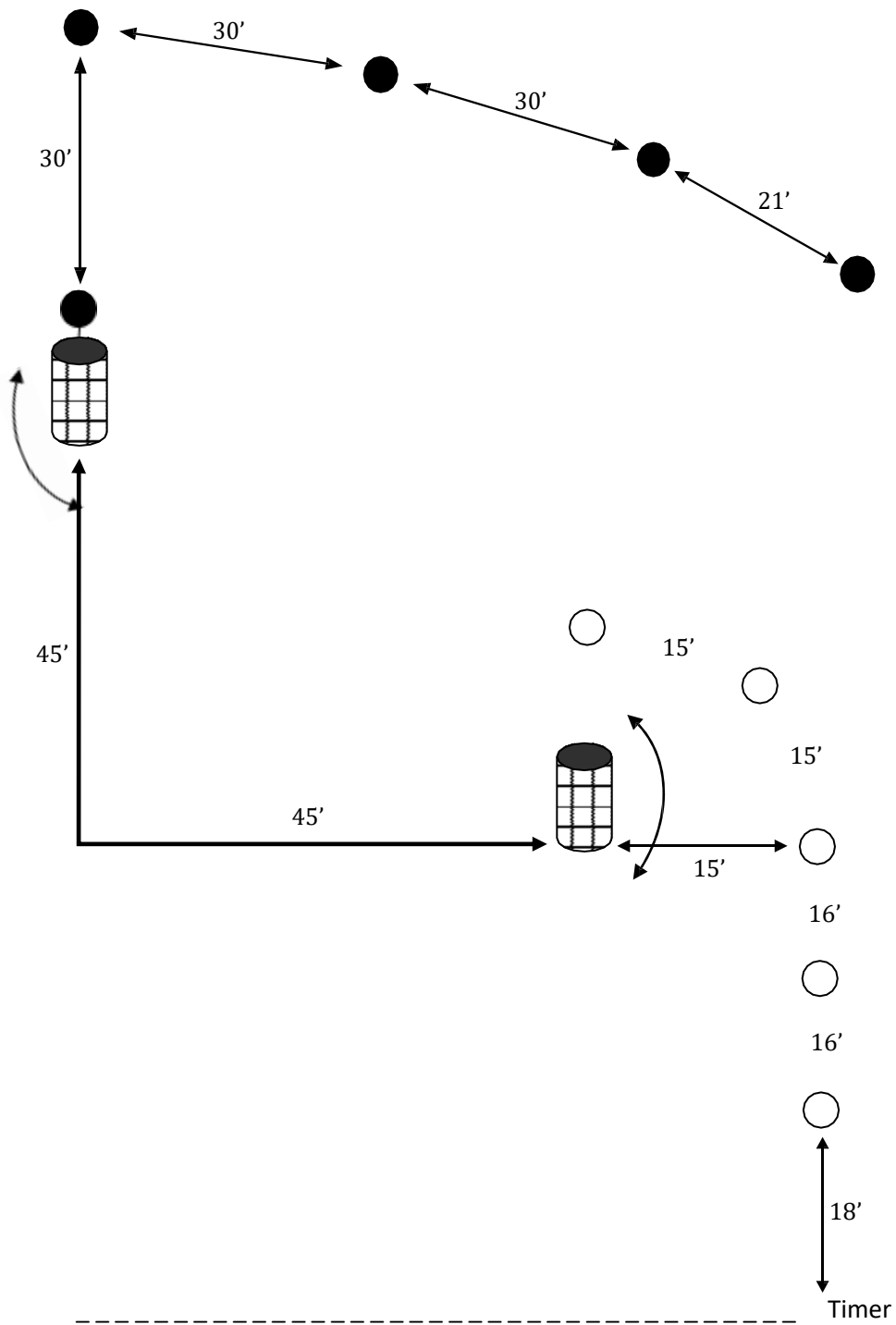

#32

Engage 5 of one color, then engage 5 of the other color.

Procedurals: 1,3

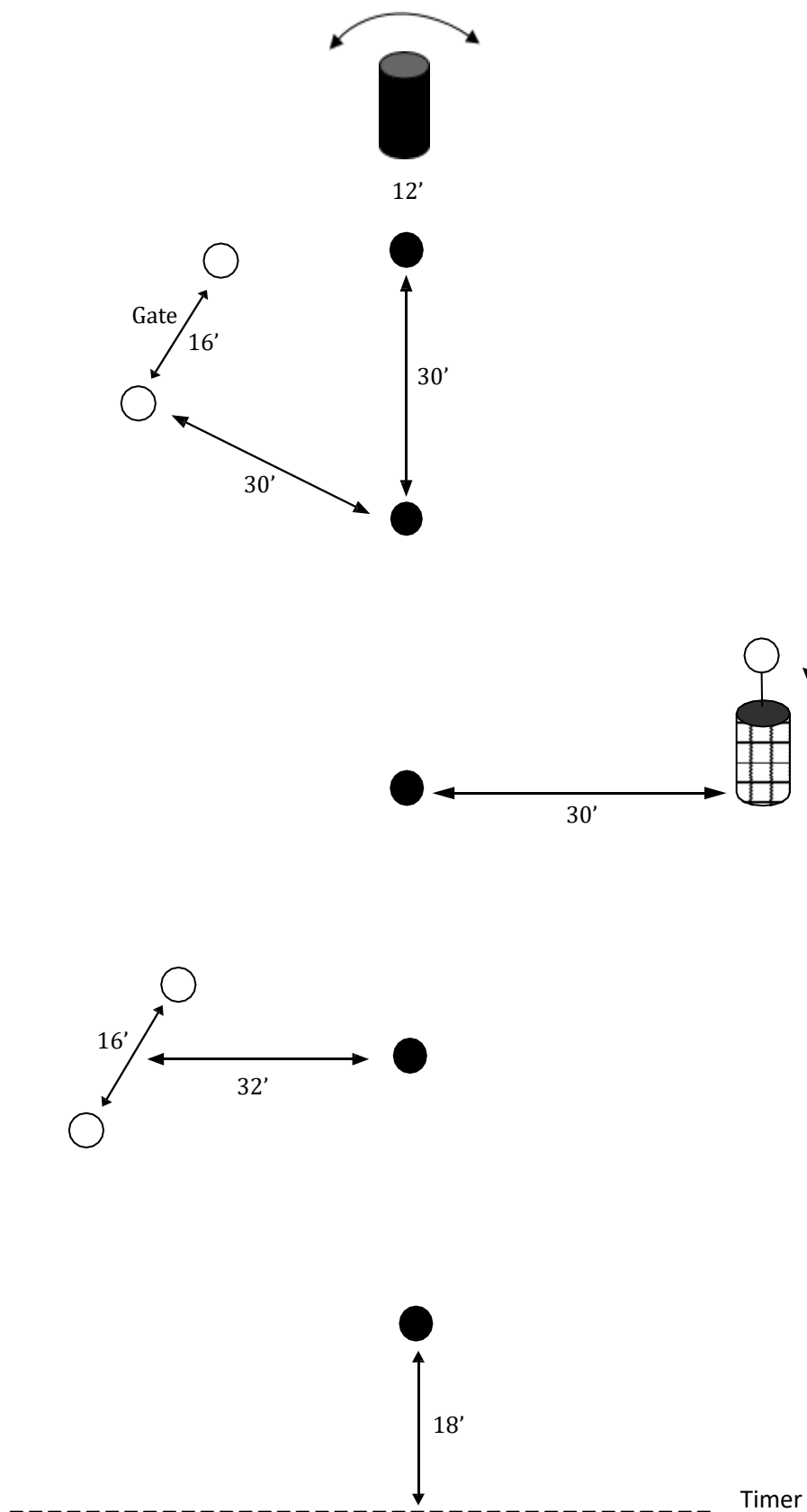

#33

Engage the random course first. Round the Rundown barrel, then engage the dark targets.

Procedurals: 1,2,3

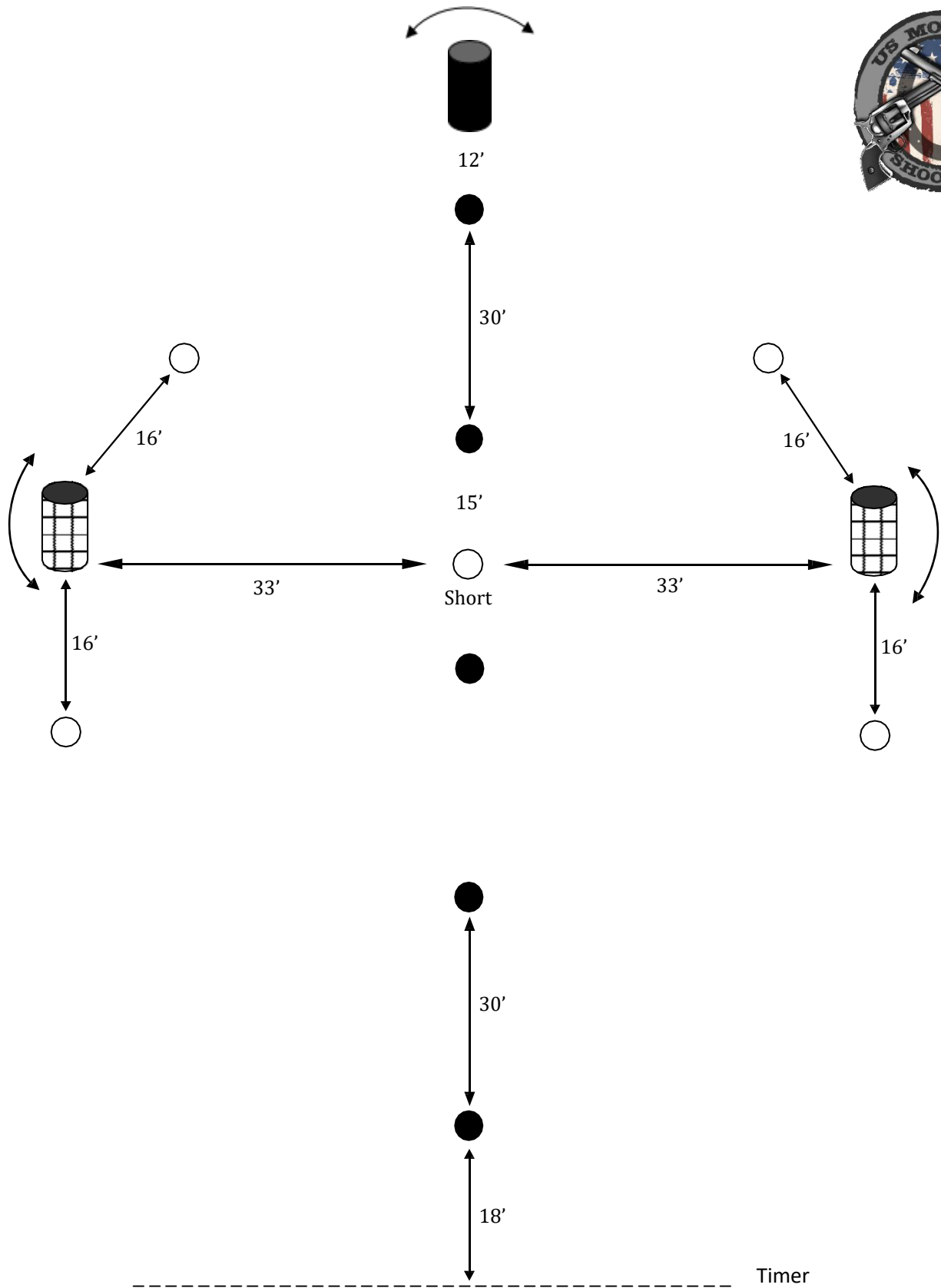

#34

Engage the random course first. Round the Rundown barrel, then engage the dark targets.

Procedurals: 1,3

Shotgun/Rifle

© 2022

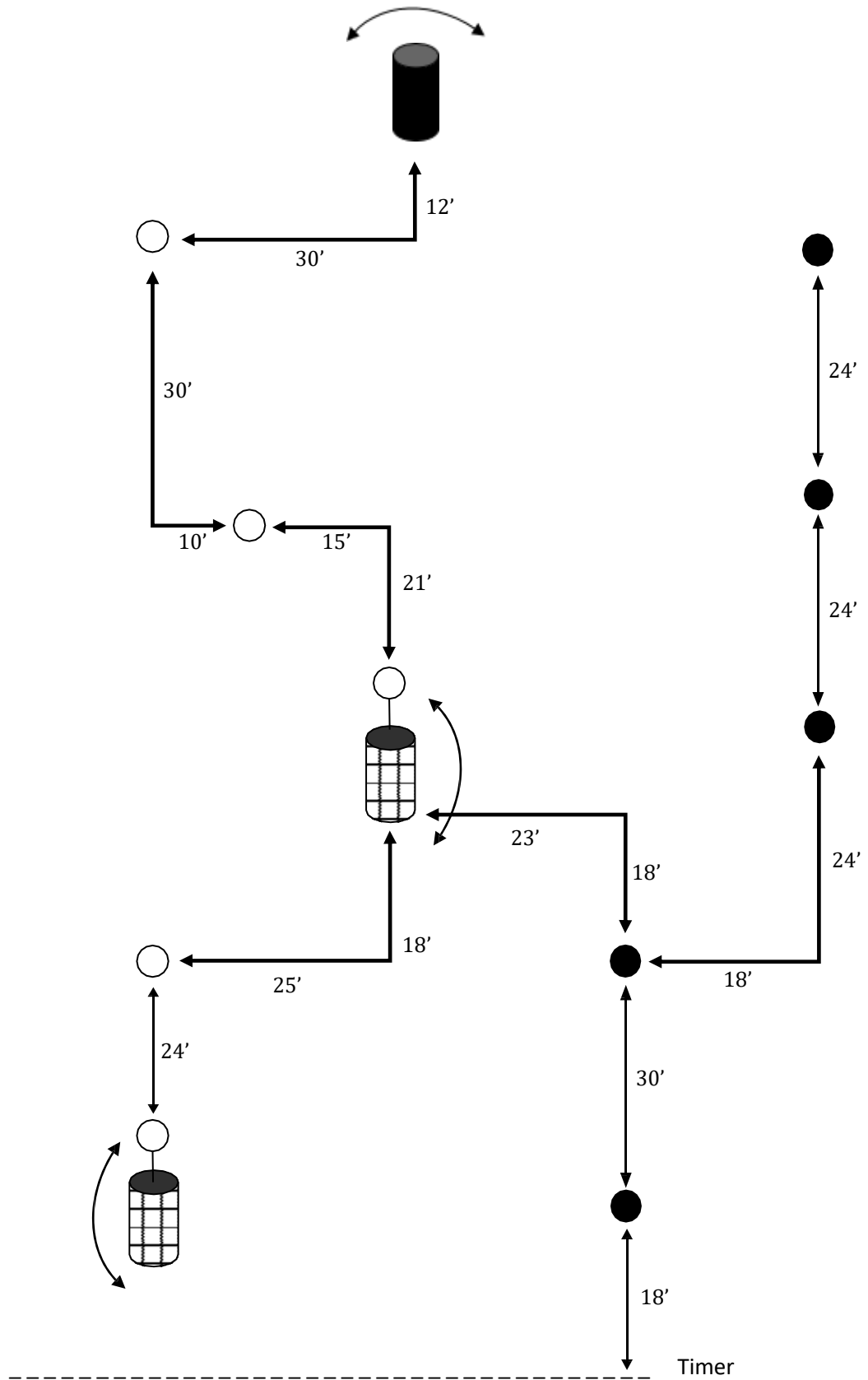

#35

Engage the random course first. Round the Rundown barrel, then engage the dark targets.

Procedurals: 1,3

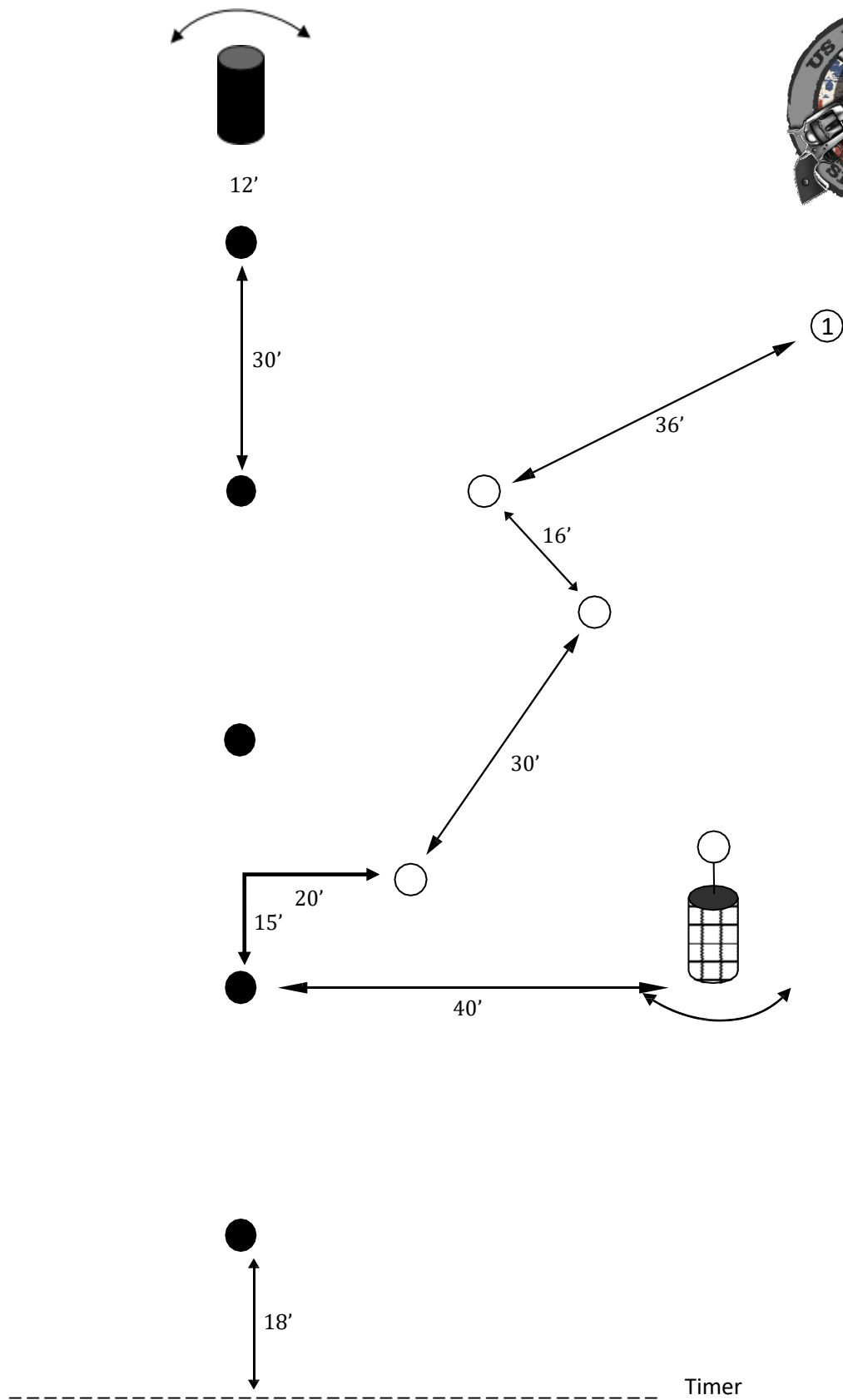

#36

Engage the farthest light target first, then engage the random course. Round the rundown barrel, then engage the dark targets.

Procedurals: 1,3,4,5

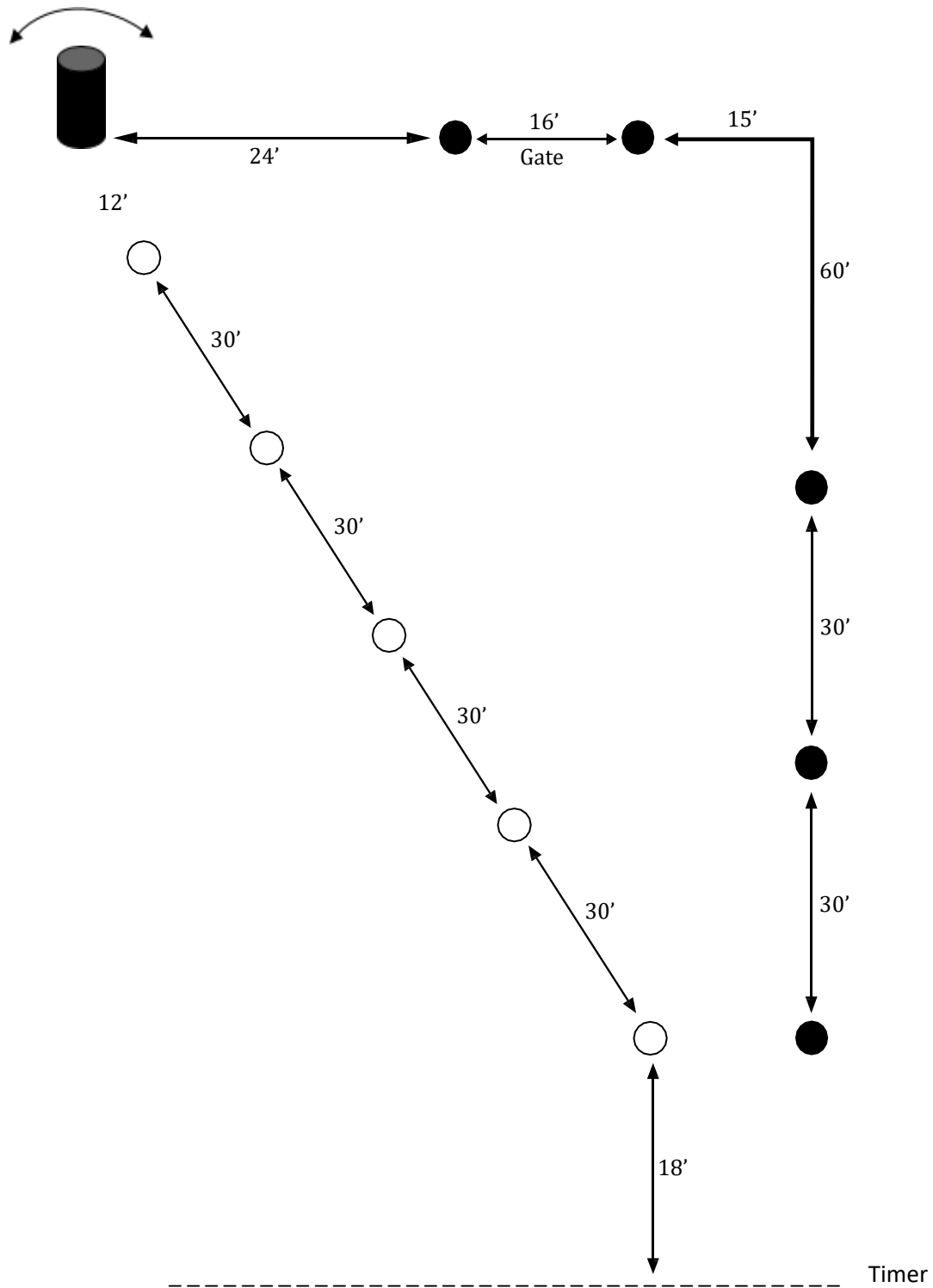

Engage 5 of one color, round the barrel, then engage 5 of the other color.

Procedurals: 1,2,3

#37

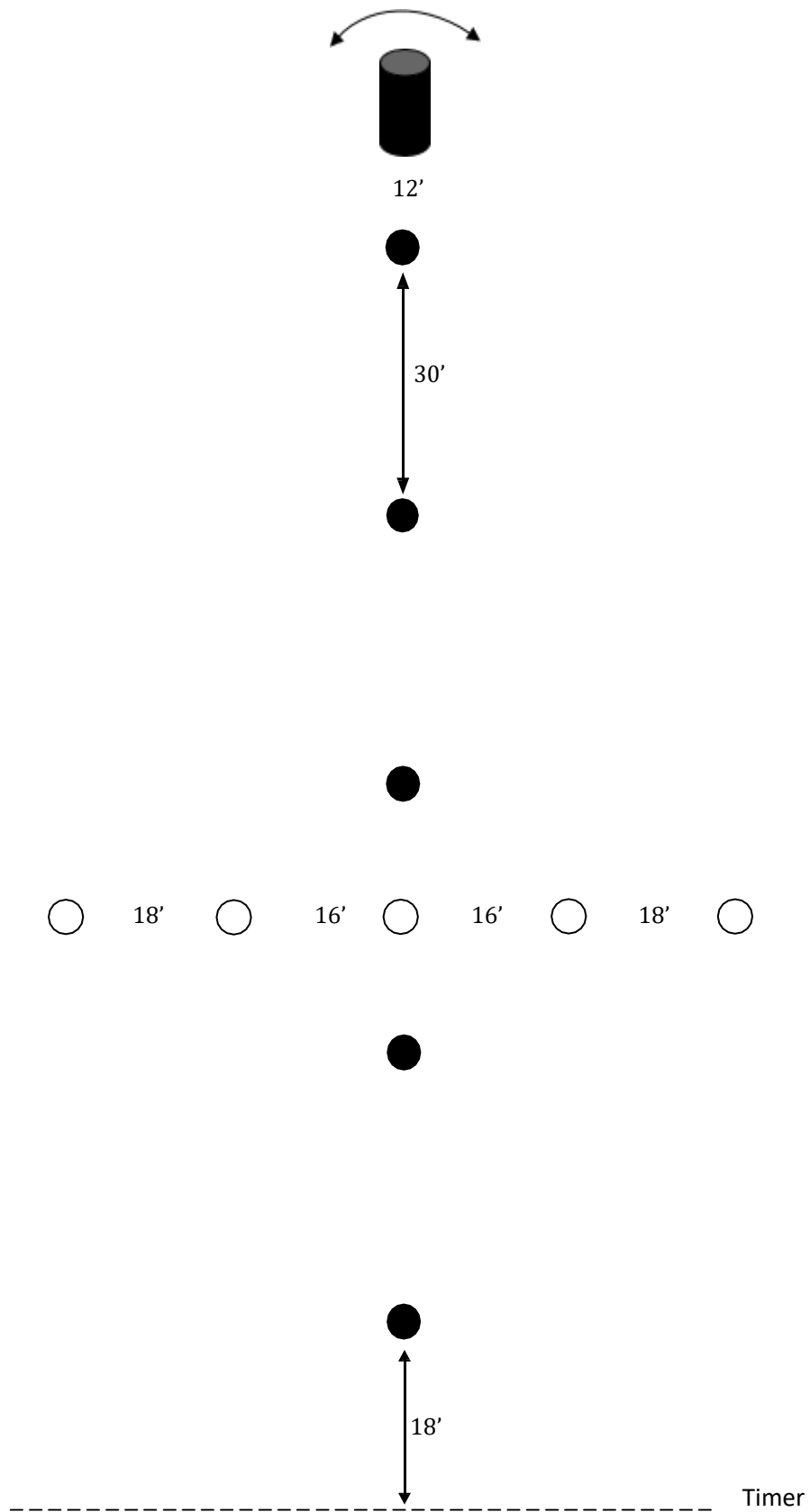

#38

Engage all light targets first. Round the Rundown barrel, then engage the dark targets.

Procedurals: 1,3

Shotgun/Rifle

© 2022

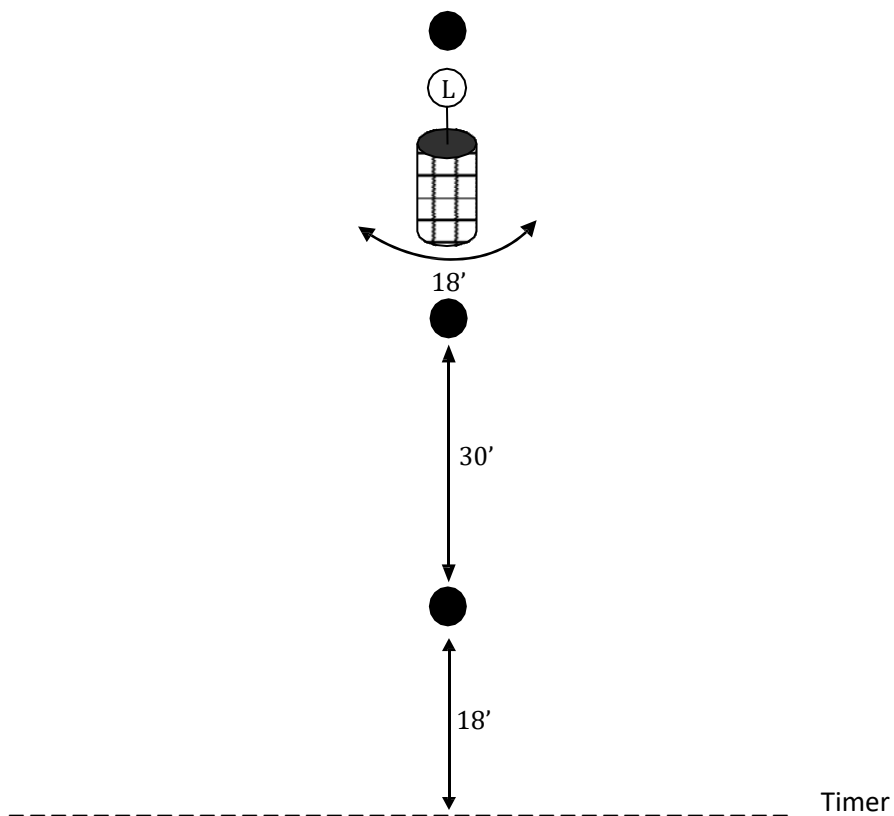
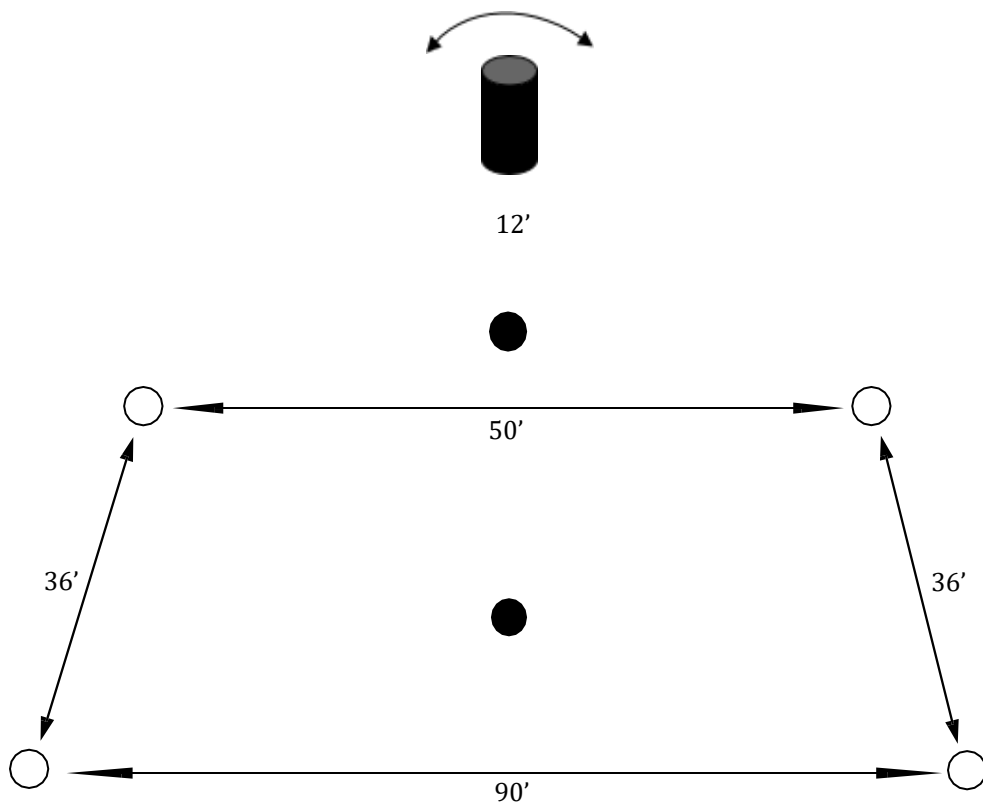

#39

Engage the random course first. Round the Rundown barrel, then engage the dark targets.

Procedurals: 1,3,4,5

Shotgun/Rifle

© 2022

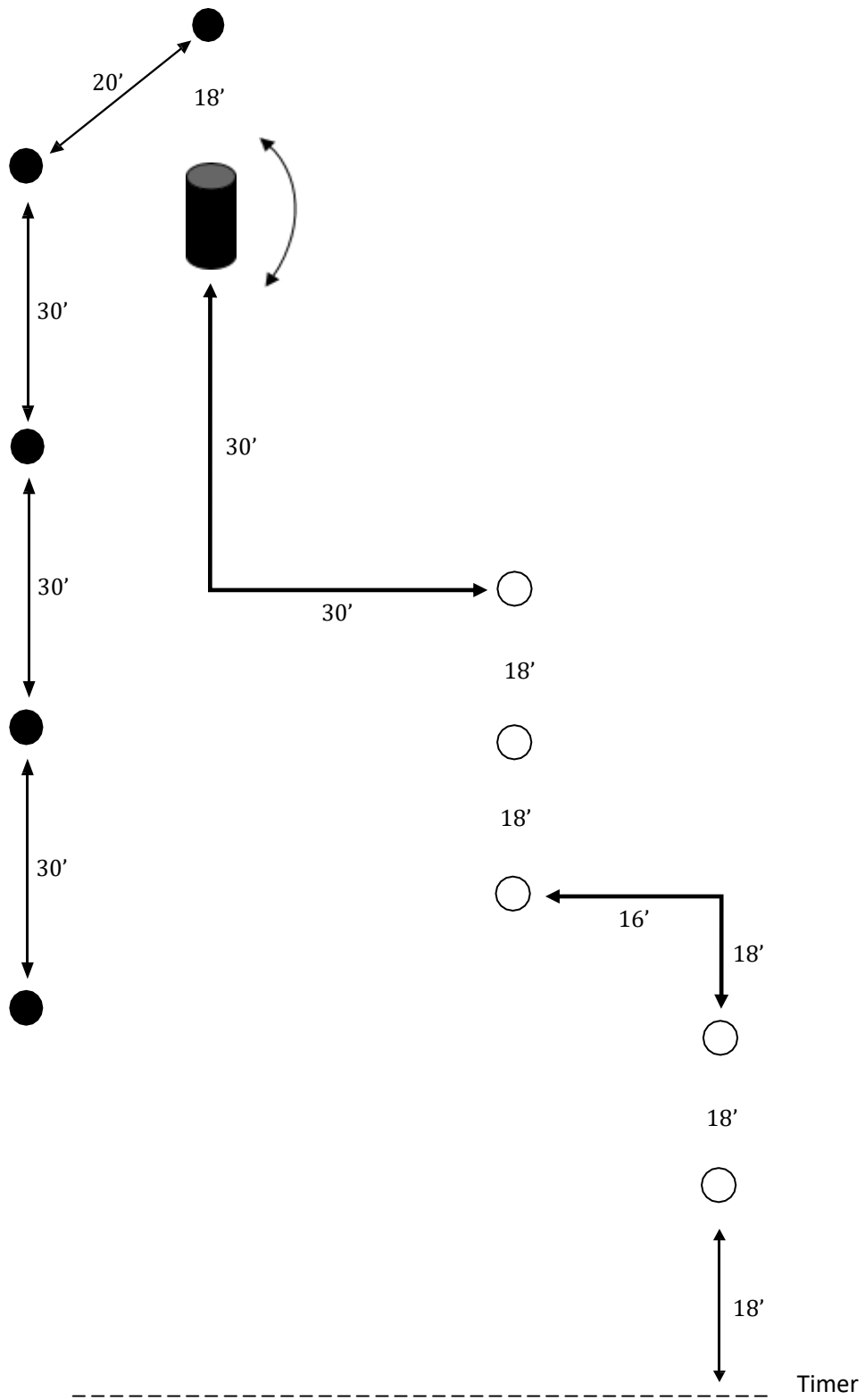

#40

Engage all light targets first. Round the Rundown barrel, then engage the dark targets.

Procedurals: 1,3

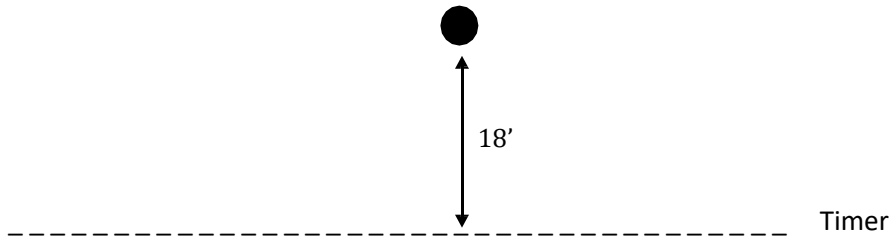
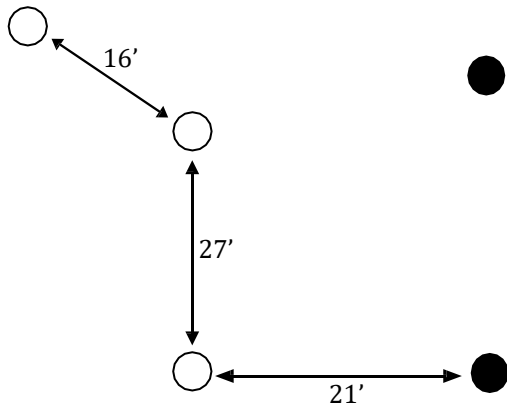
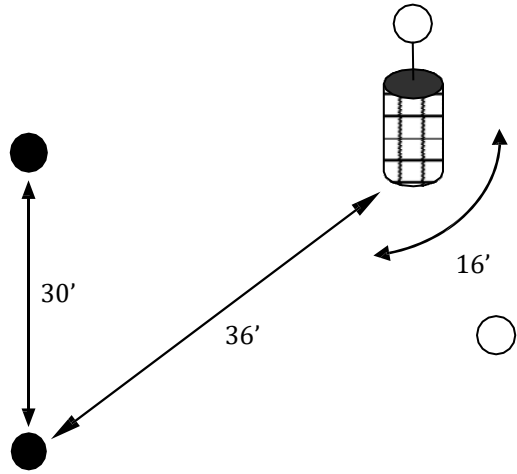

#41

Engage the random course first, then engage the dark targets.

Procedurals: 1,3

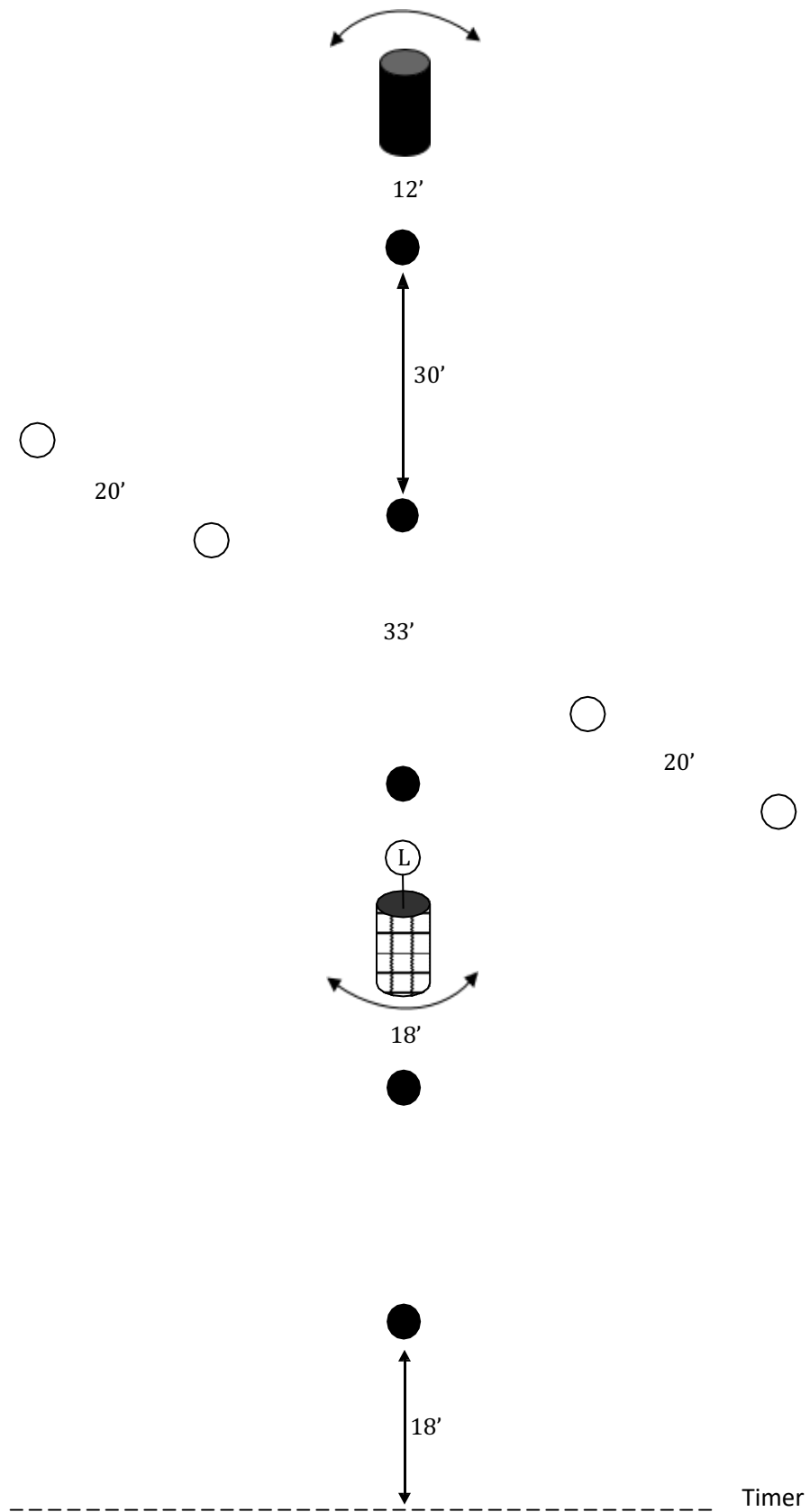

#42

Engage the random course first. Round the Rundown barrel, then engage the dark targets.

Procedurals: 1,2,3

Shotgun/Rifle

© 2022

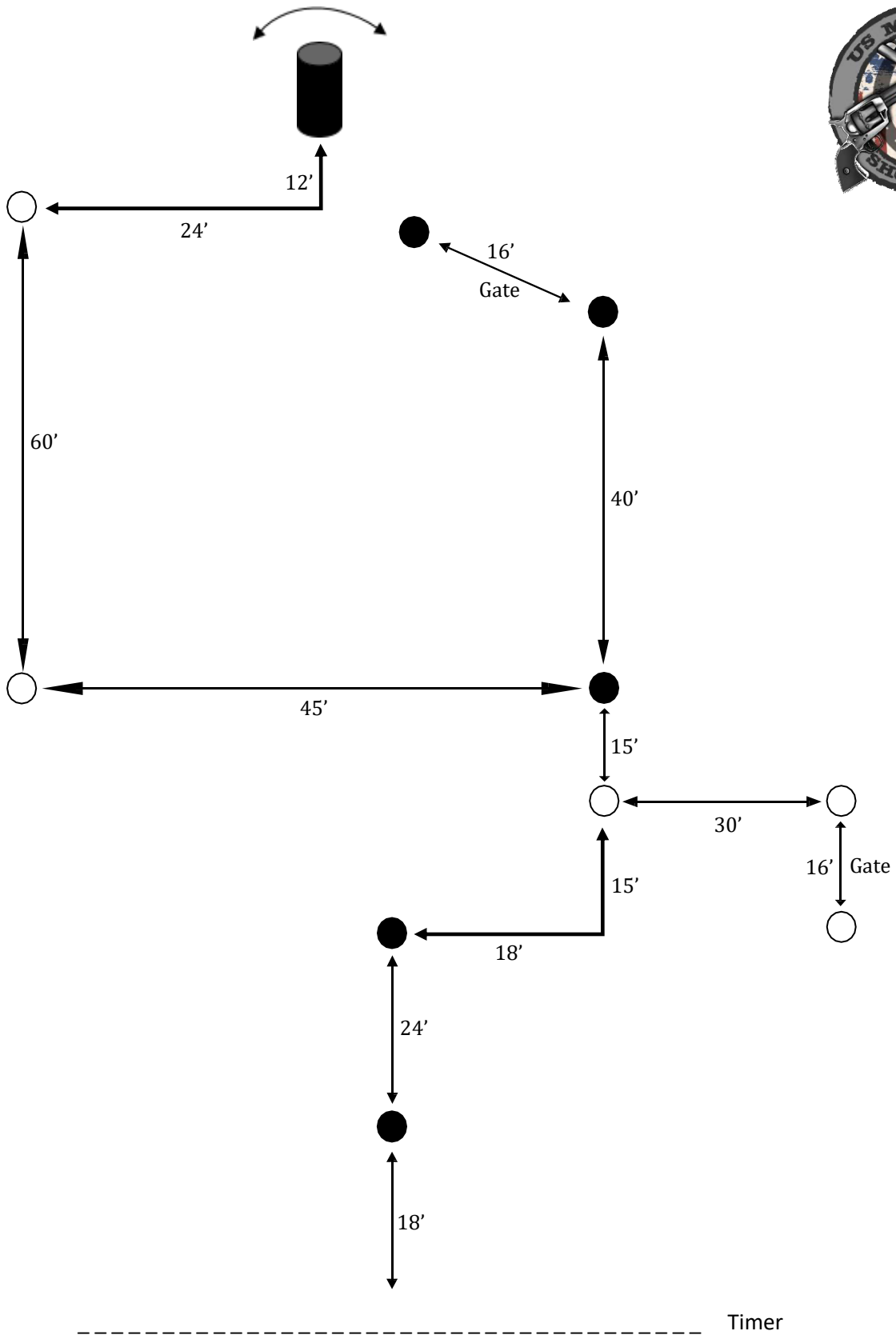

#43

Engage all light targets first. Round the Rundown barrel, then engage the dark targets.

Procedurals: 1,2,3

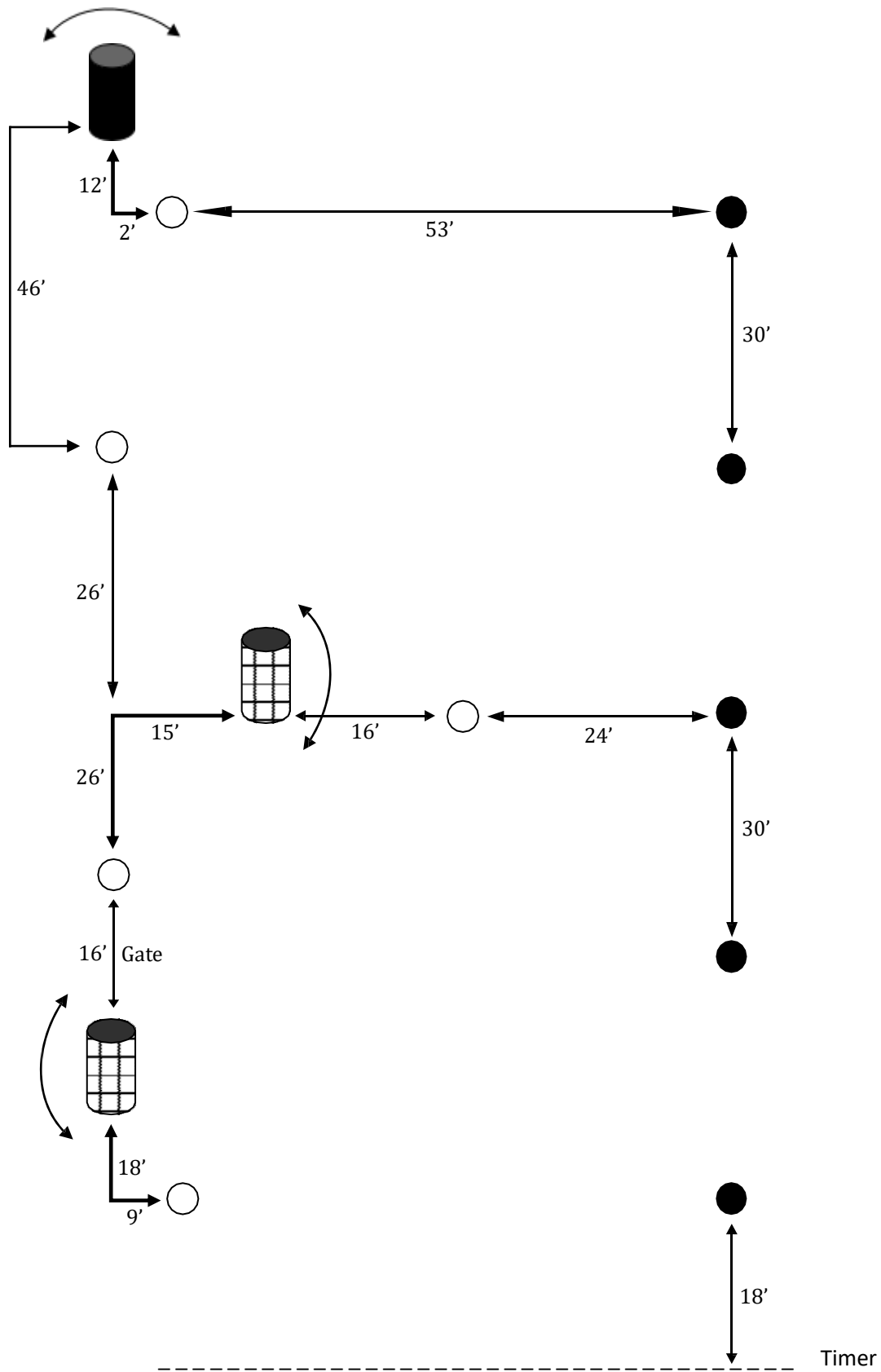

#44 - Certified

Engage the random course first. Round the Rundown barrel, then engage the dark targets.

Procedurals: 1,2,3

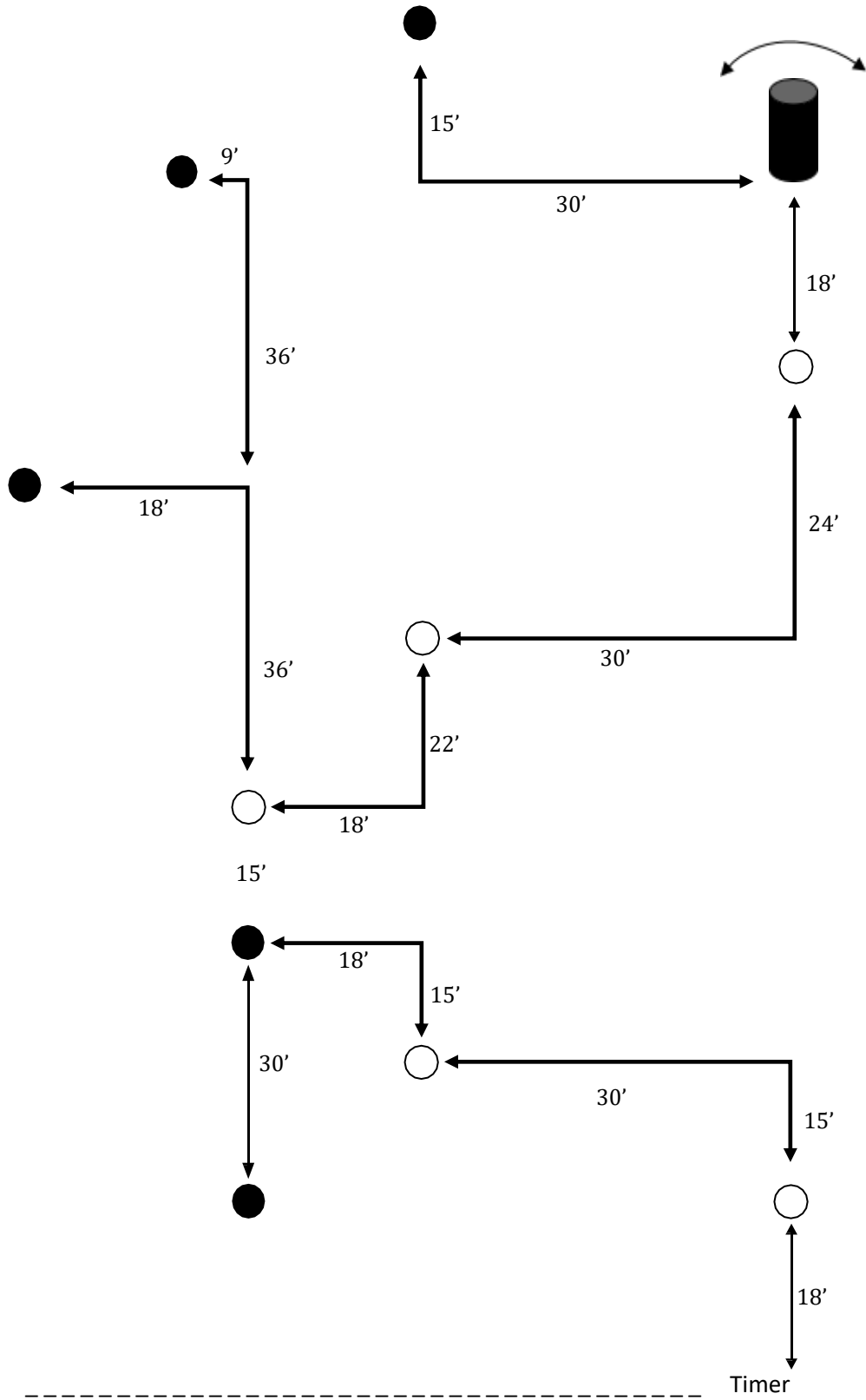

#45

Engage 5 of one color, then engage 5 of the other color.

Procedurals: 1,3

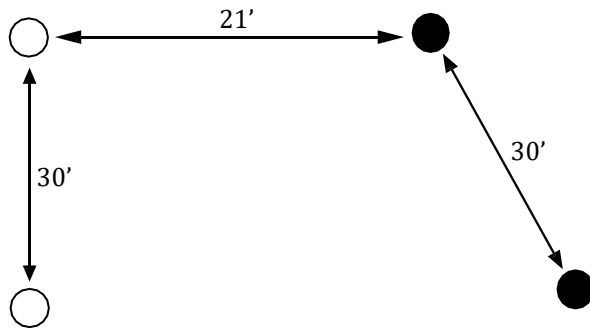
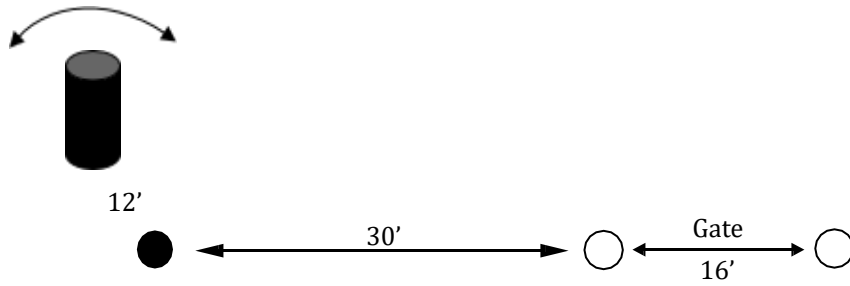

#46

Engage all light targets first. Round the Rundown barrel, then engage the dark targets.

Procedurals: 1,2,3

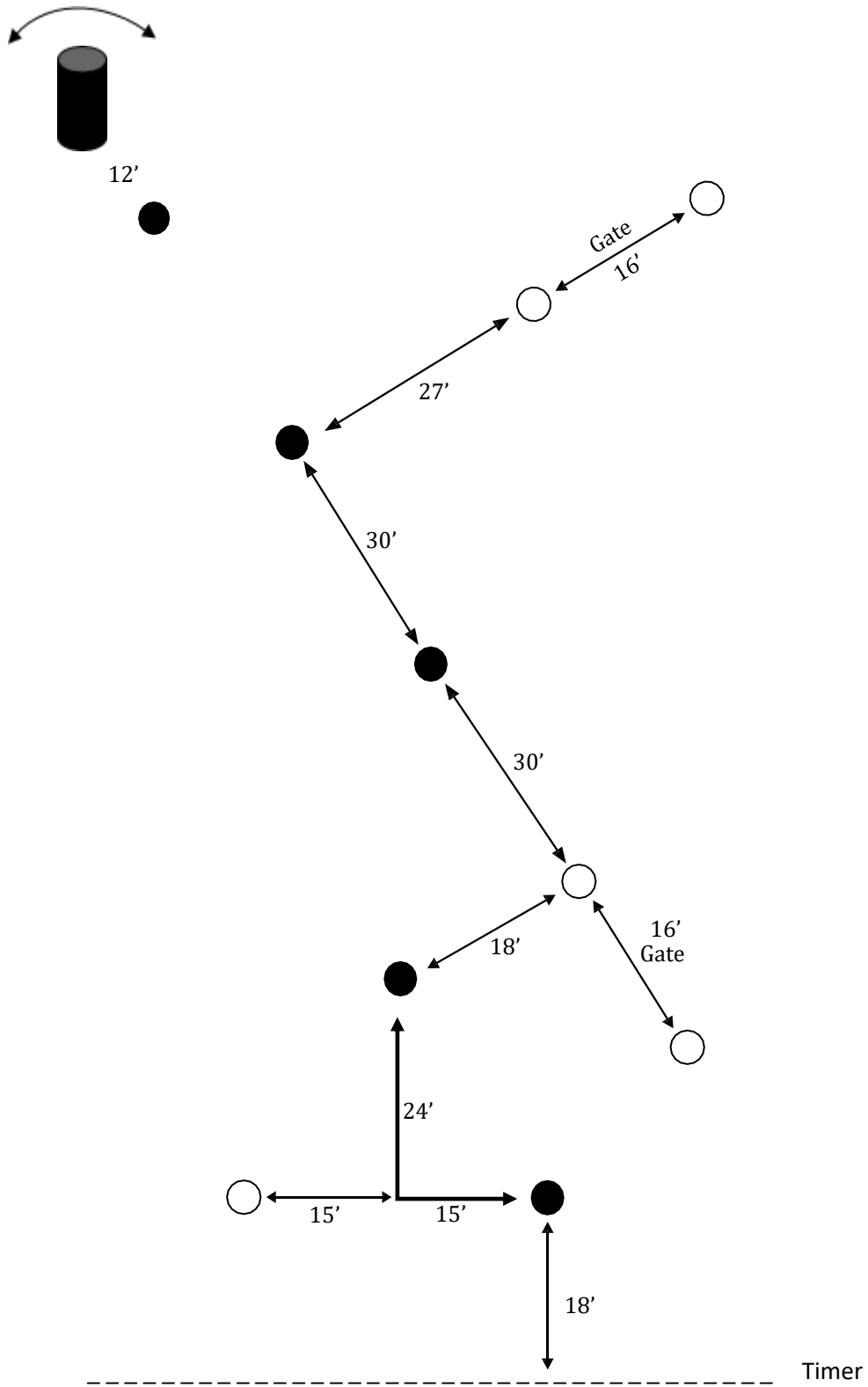

#47

Engage all light targets first. Round the Rundown barrel, then engage the dark targets.

Procedurals: 1,2,3

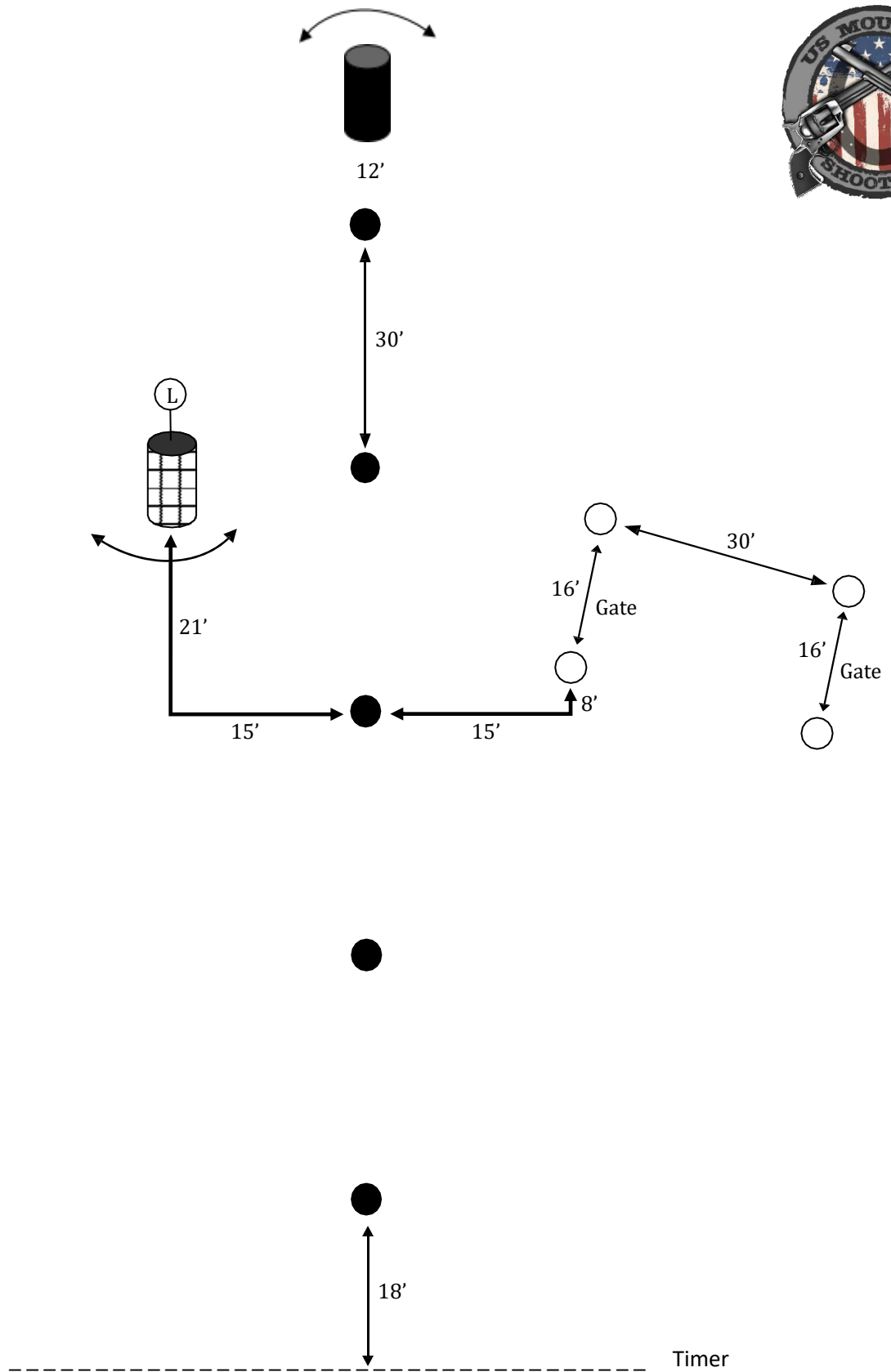

#48

Engage the random course first. Round the Rundown barrel, then engage the dark targets.

Procedurals: 1,3,4,5

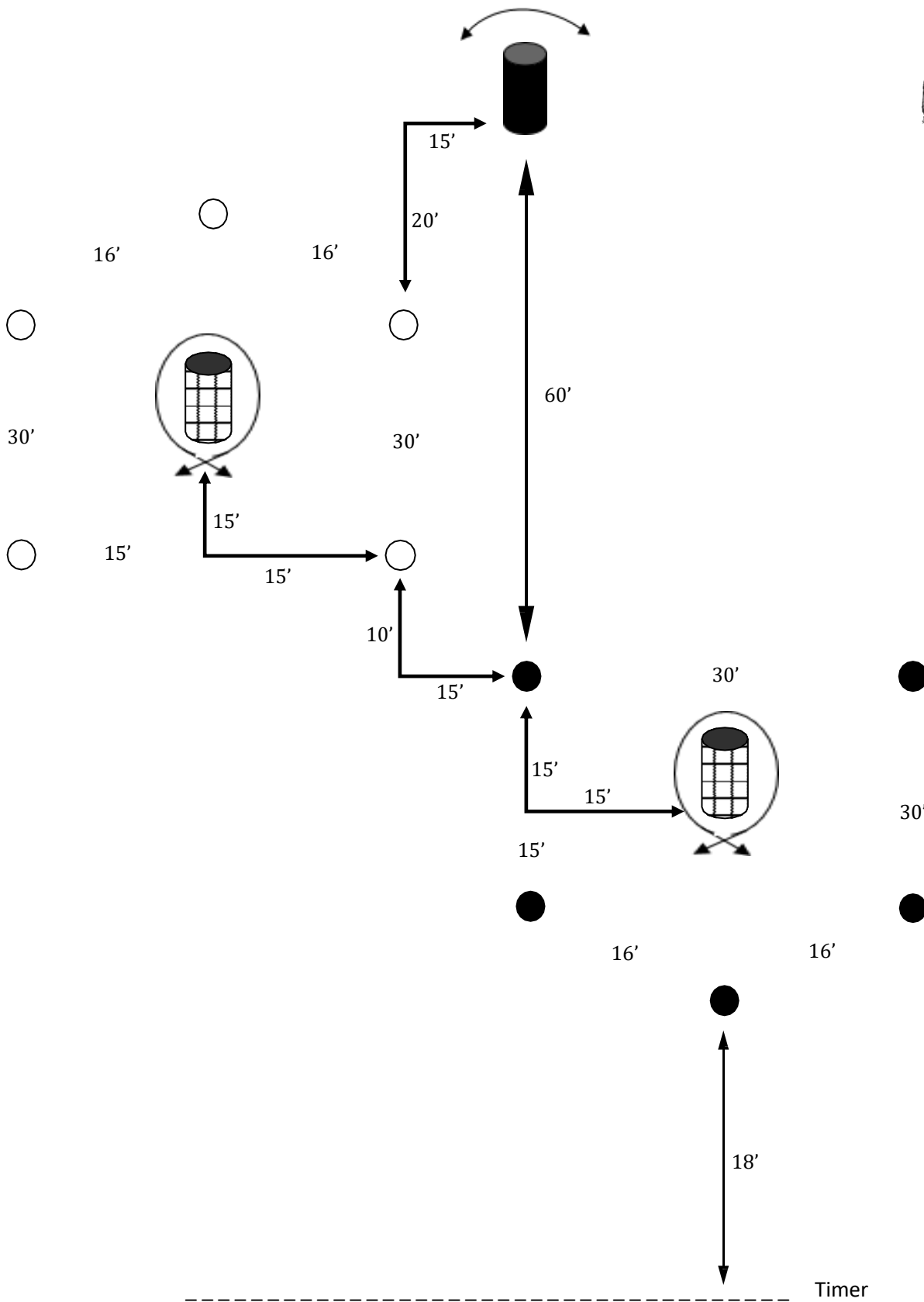

Engage 5 of one color, round the Rundown barrel, then engage 5 of the other color.

Procedurals: 1,3

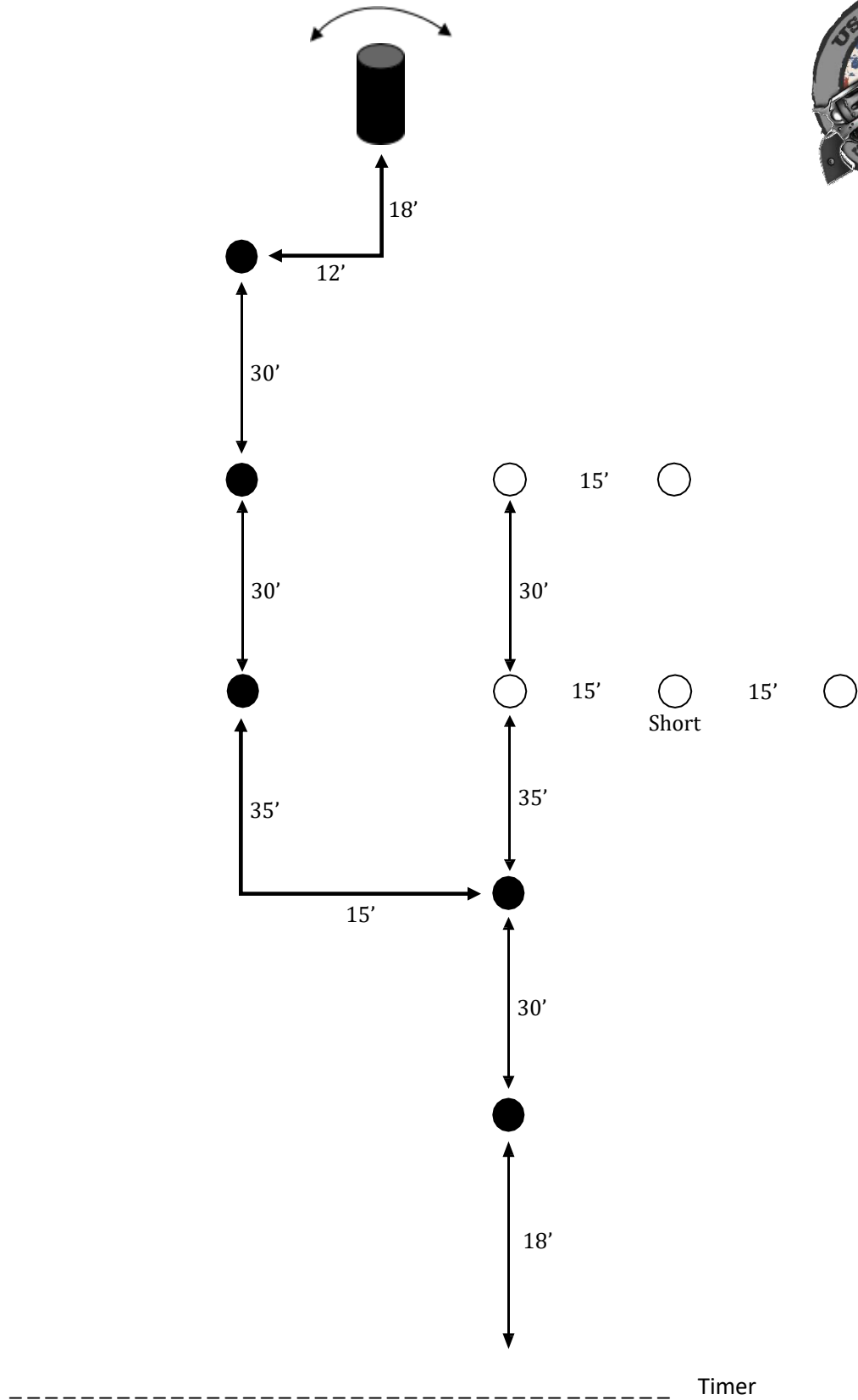

Engage all light targets first. Round the Rundown barrel, then engage the dark targets.

Procedurals: 1,3

#50

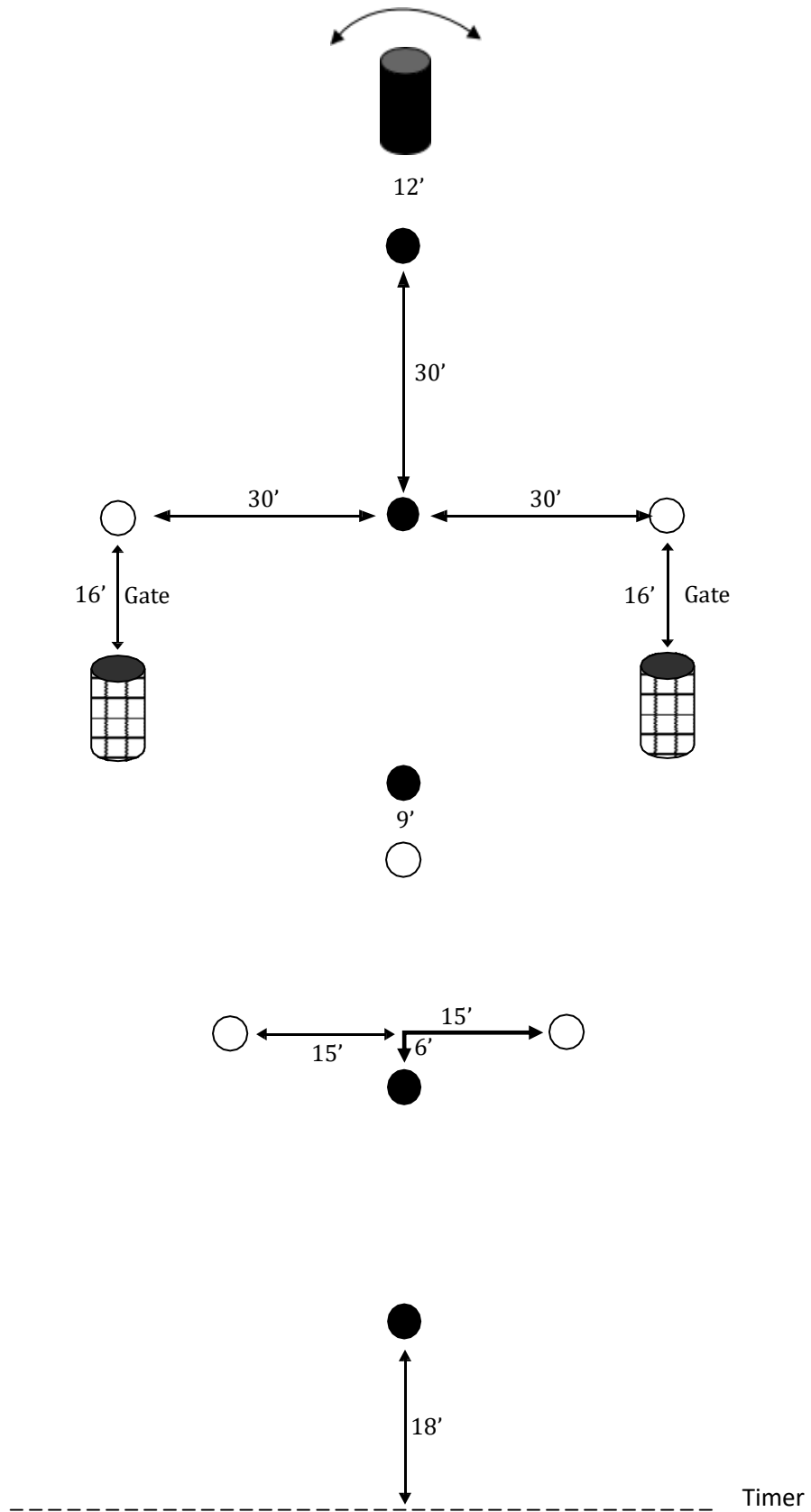

#51

Engage the random course first. Round the Rundown barrel, then engage the dark targets.

Procedurals: 1,2,3

Shotgun/Rifle

© 2022

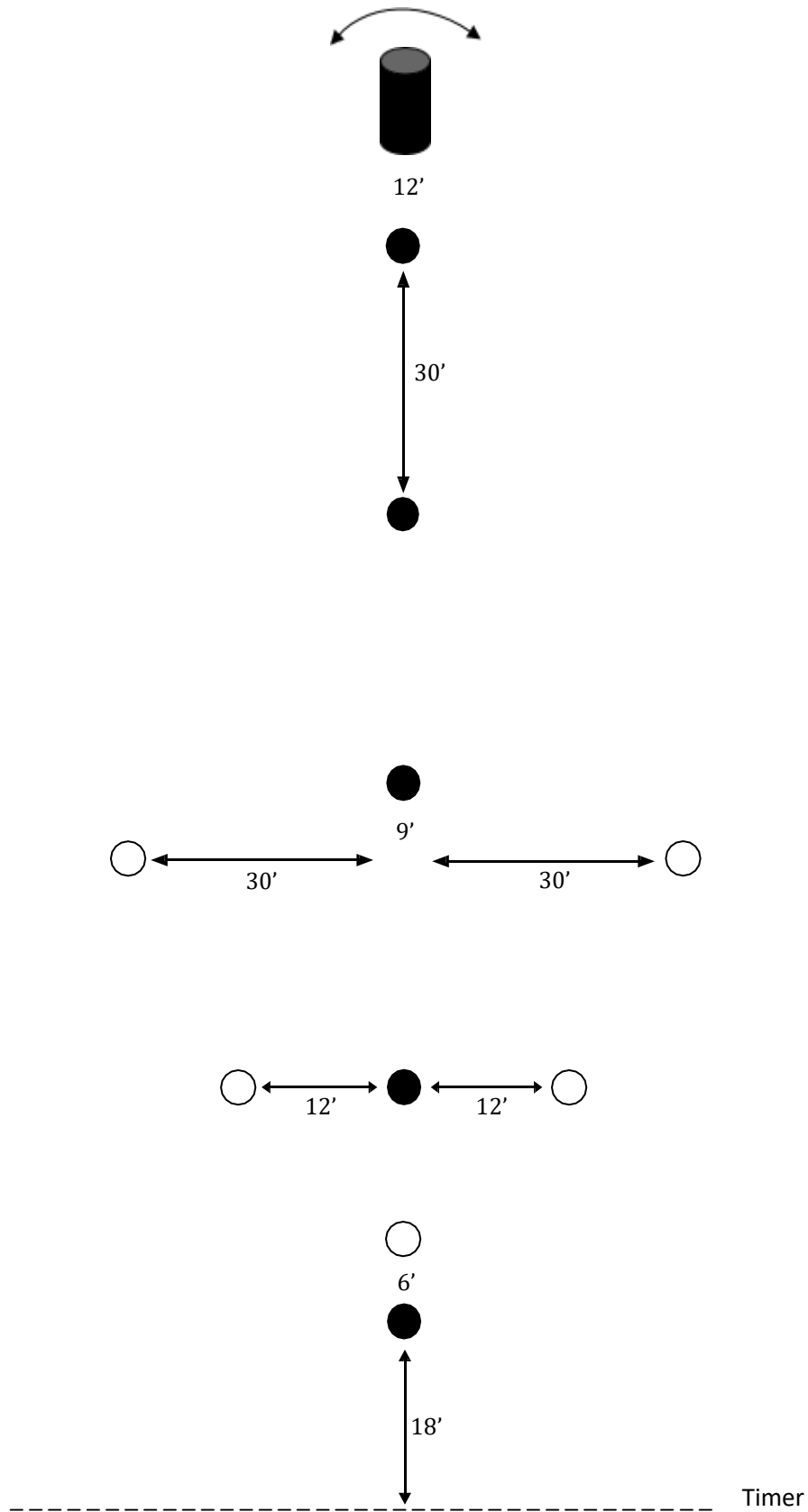

#52

Engage all light targets first. Round the Rundown barrel, then engage the dark targets.

Procedurals: 1,3

Shotgun/Rifle

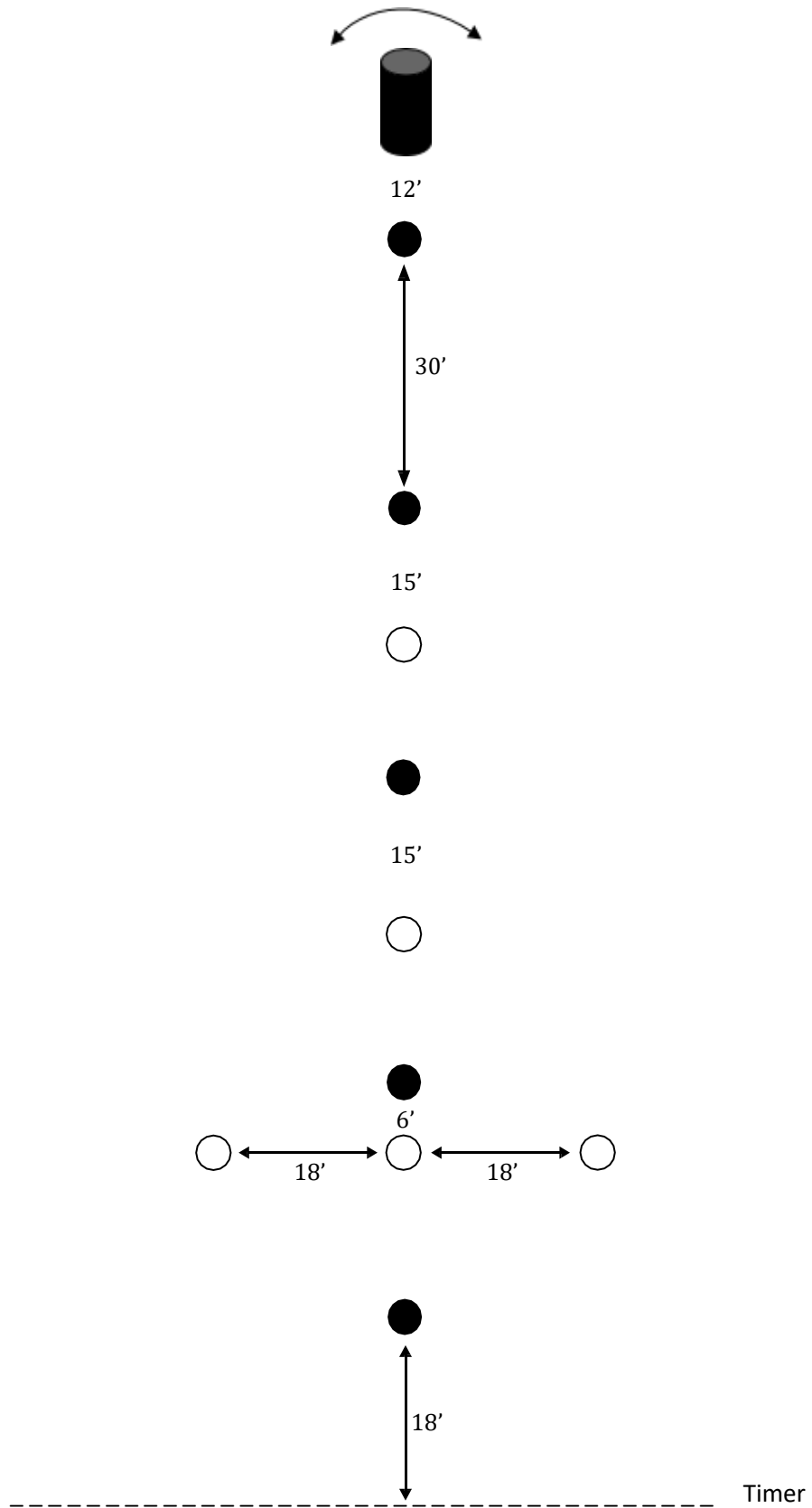

#53

Engage all light targets first. Round the Rundown barrel, then engage the dark targets.

Procedurals: 1,2,3

Shotgun/Rifle

© 2022

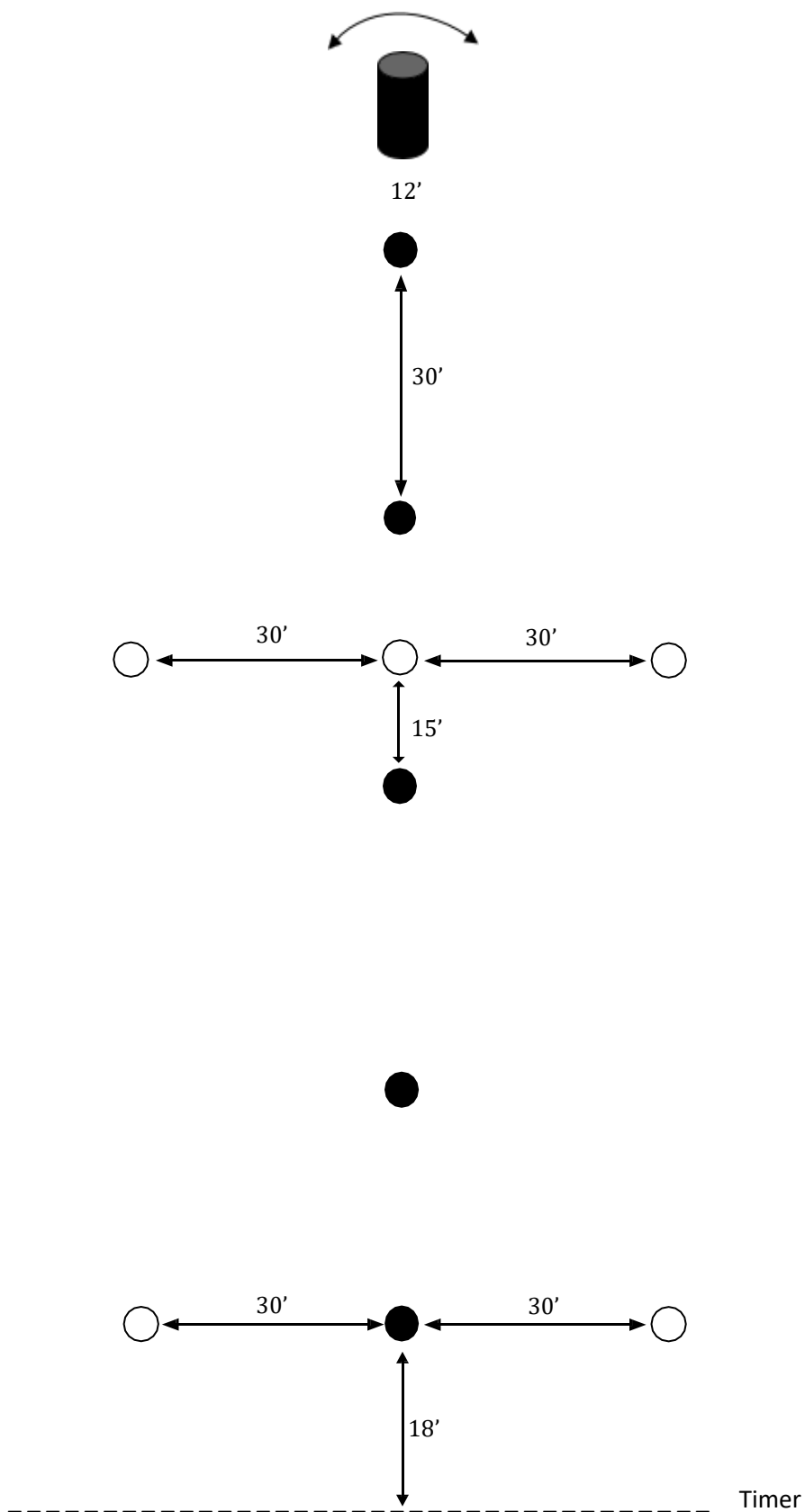

#54

Engage all light targets first. Round the Rundown barrel, then engage the dark targets.

Procedurals: 1,3

Shotgun/Rifle

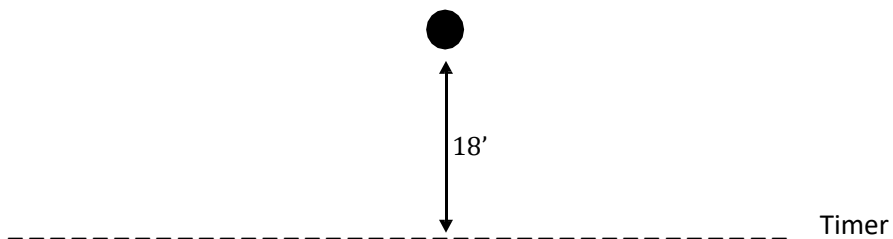
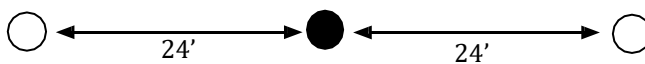
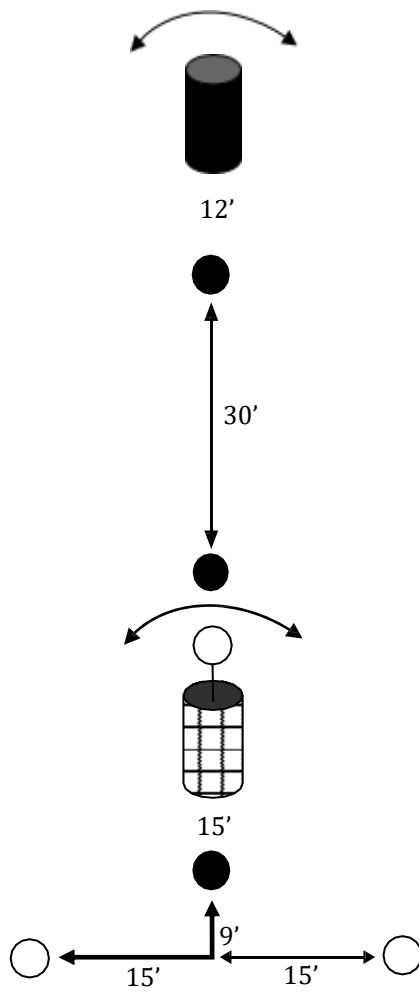

#55

Round the random barrel first (target on the barrel may be engaged coming in or coming out of the turn), then engage the light targets. Round the Rundown barrel, then engage the dark targets.

Procedurals: 1,3

Shotgun/Rifle

© 2022

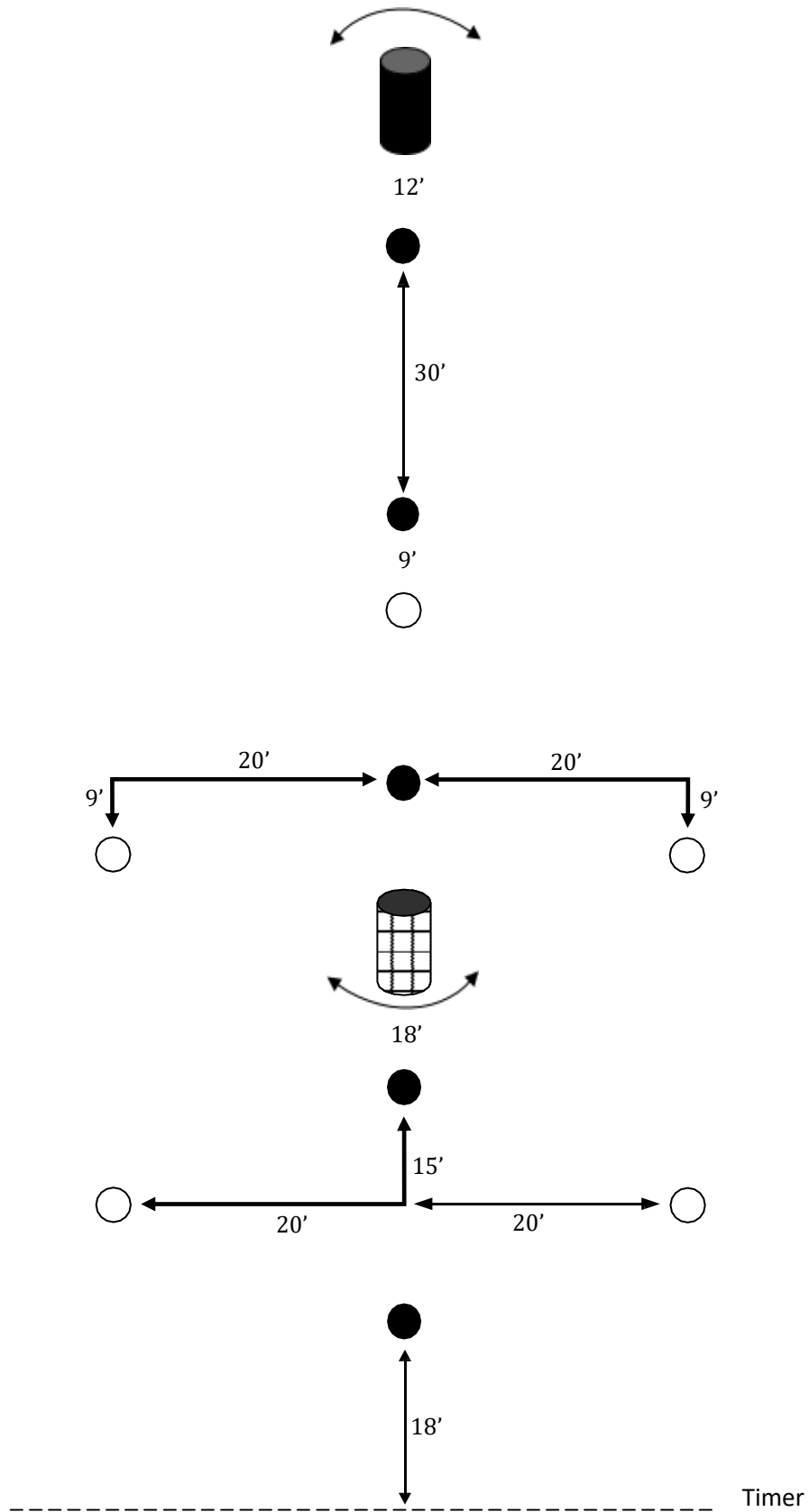

#56

Engage all light targets first, then round the random barrel. Round the Rundown barrel, then engage the dark targets.

Procedurals: 1,2,3

Shotgun/Rifle

© 2022

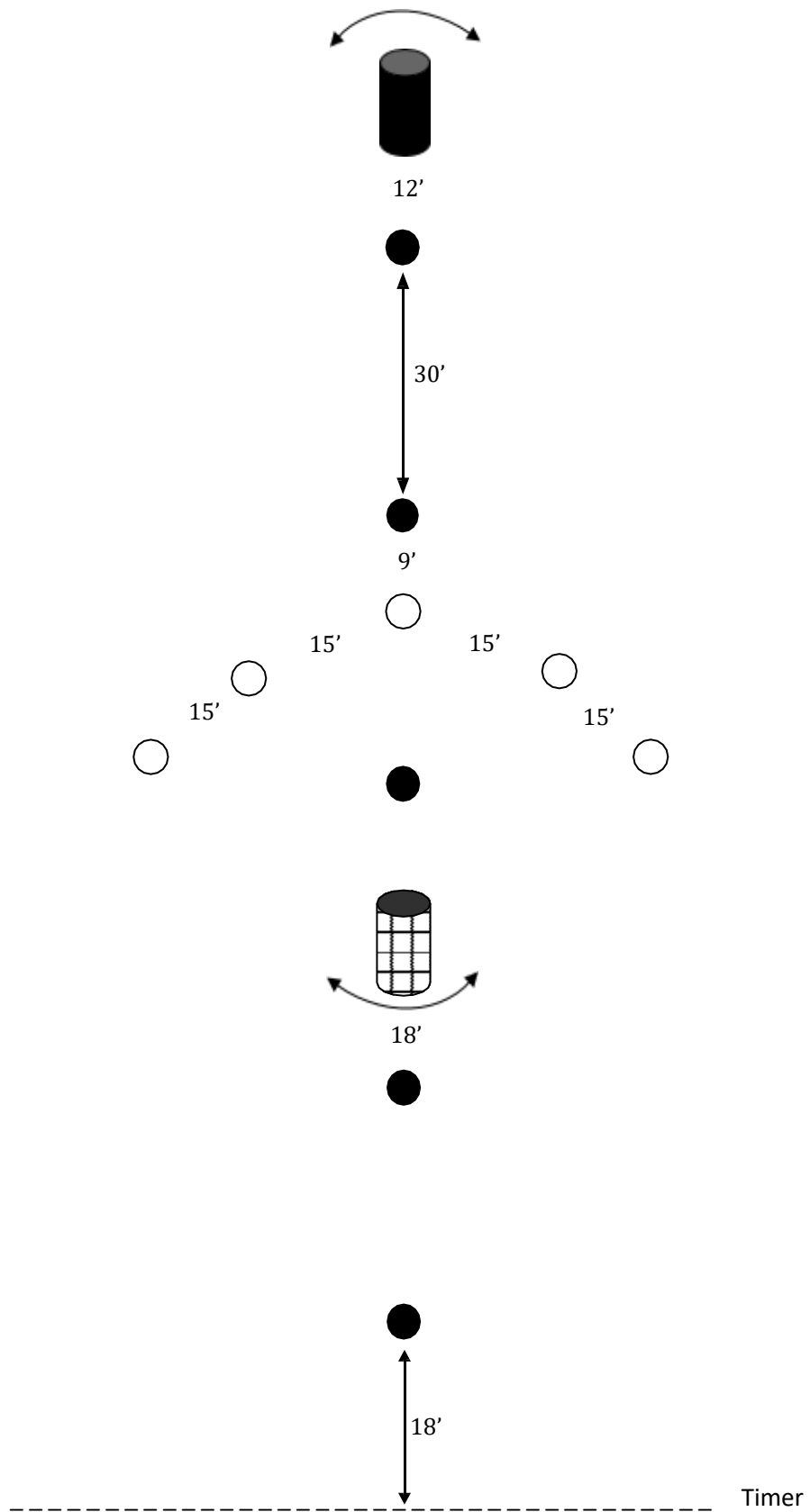

#57

Engage all light targets first, then round the random barrel. Round the Rundown barrel, then engage the dark targets.

Procedurals: 1,3

Shotgun/Rifle

© 2022

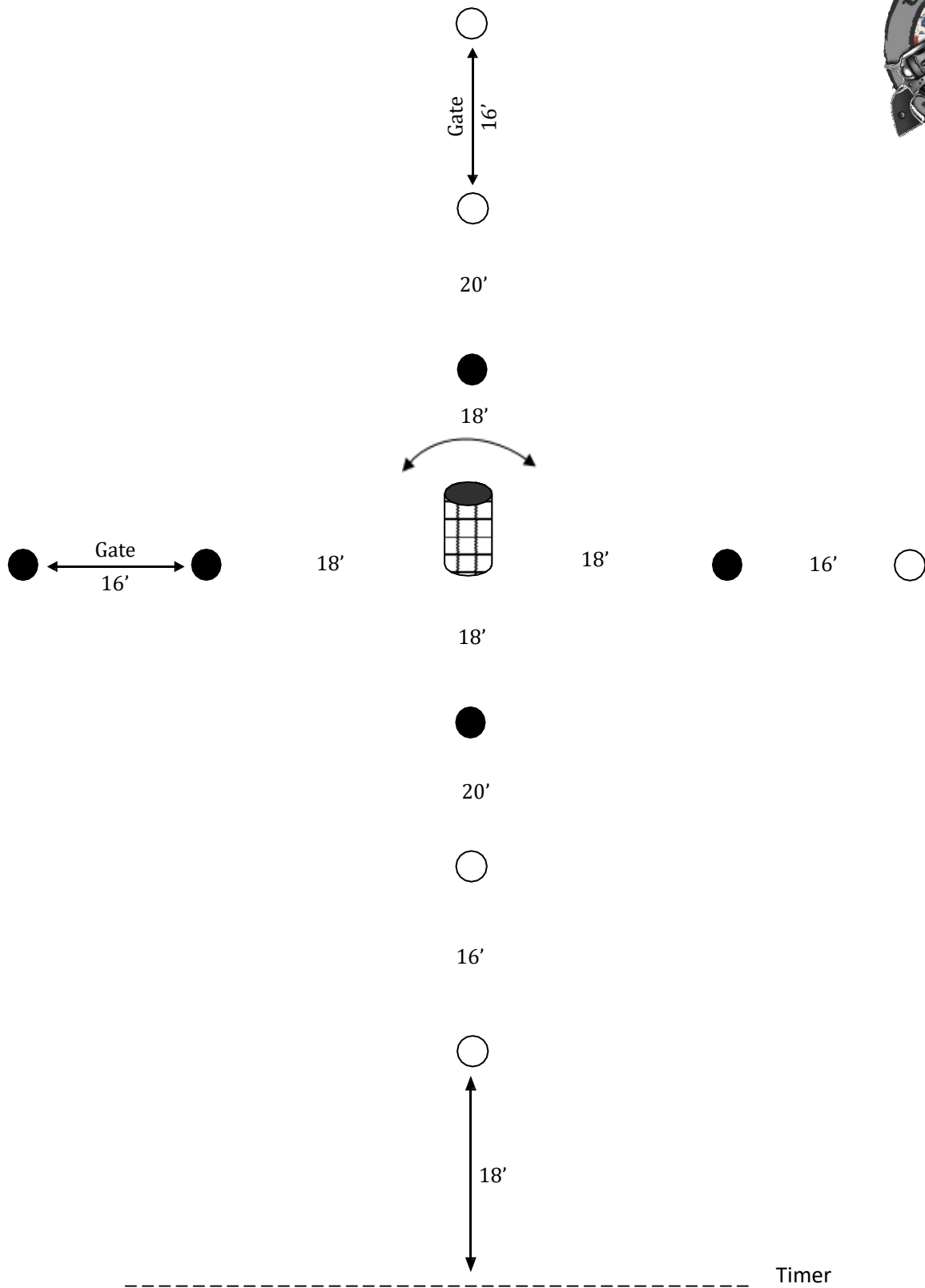

#58

Engage 5 of one color, then engage 5 of the other color.

Procedurals: 1,2,3

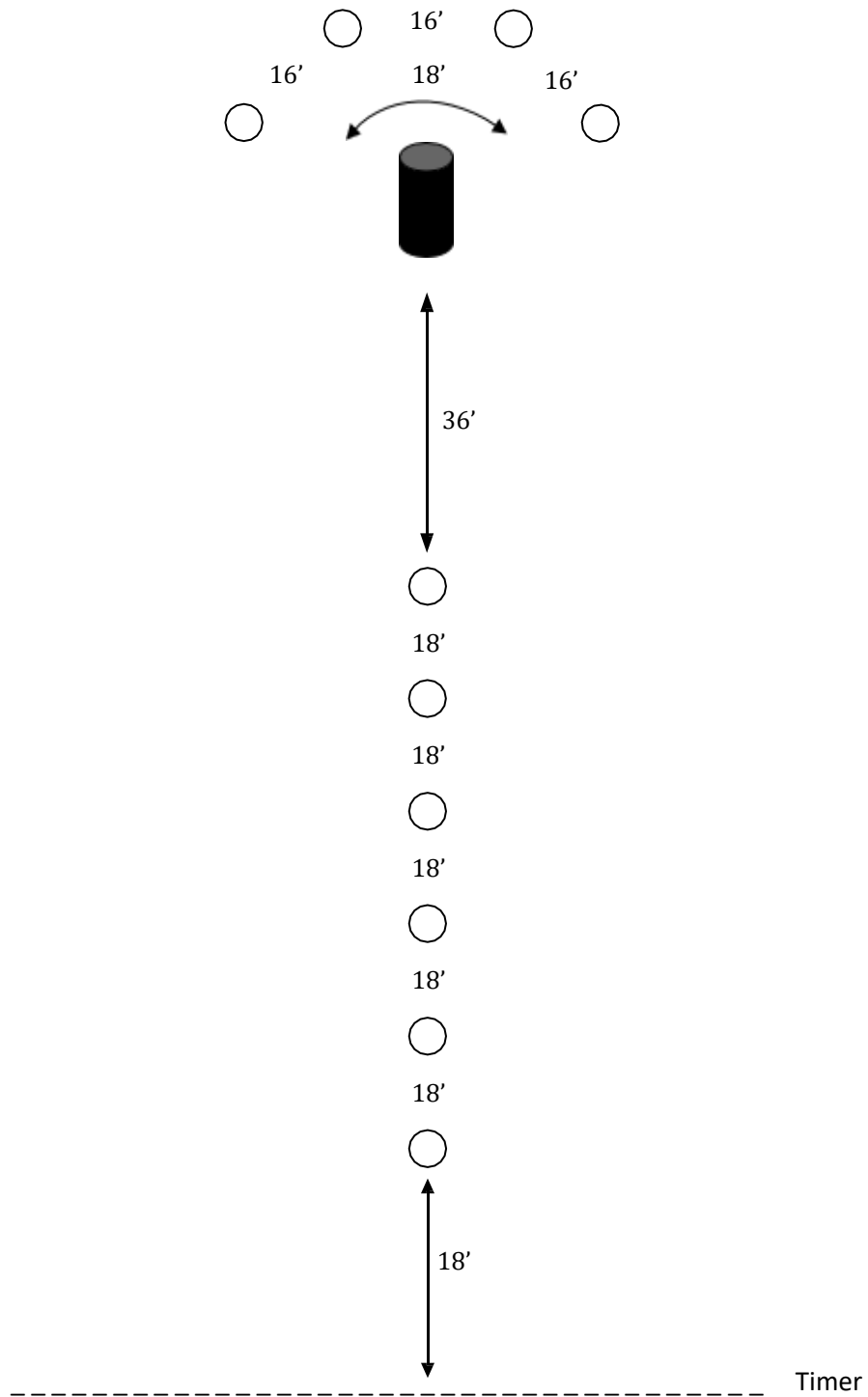

Engage 10 targets in any order.

Procedurals: 1

#59

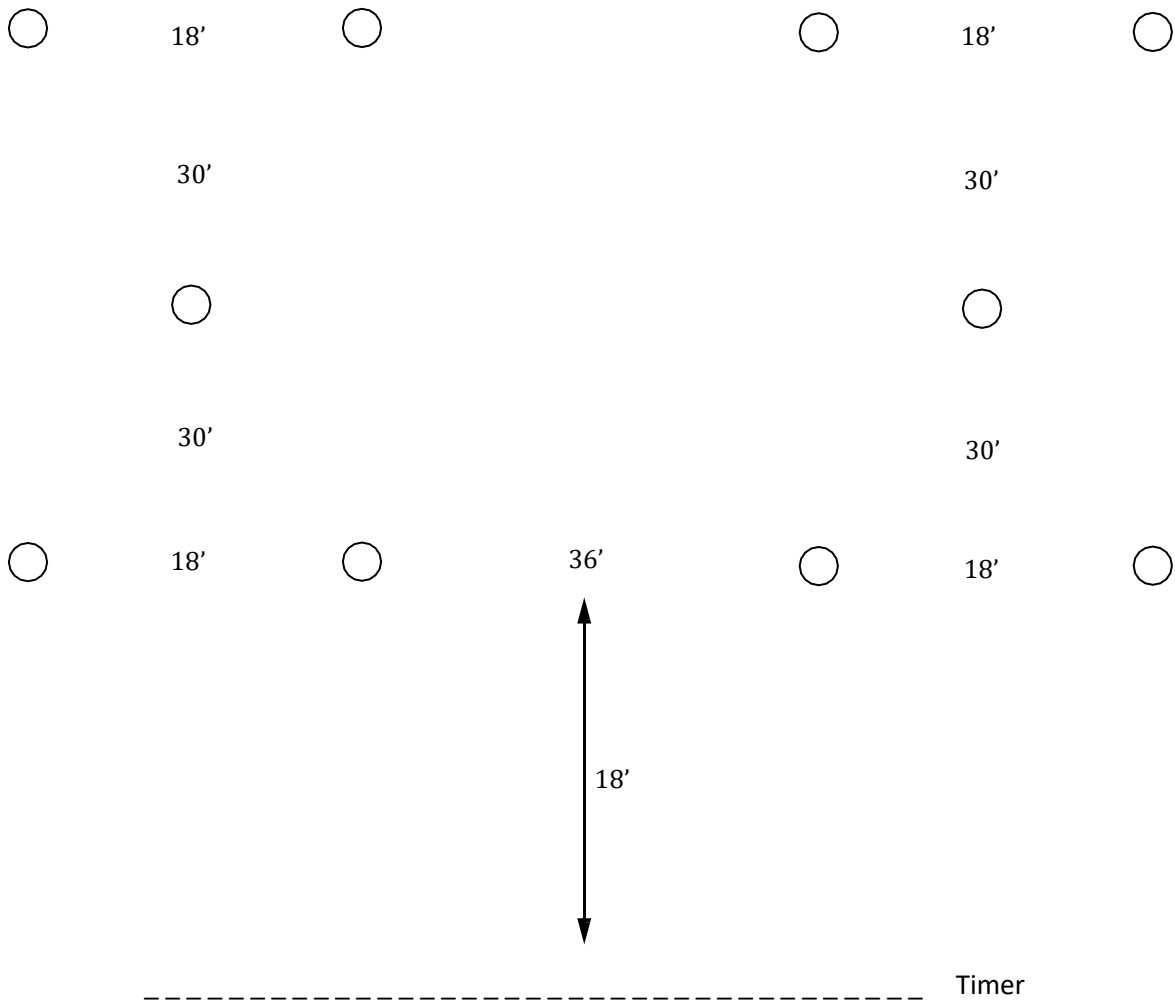

Engage 10 targets in any order.

#60

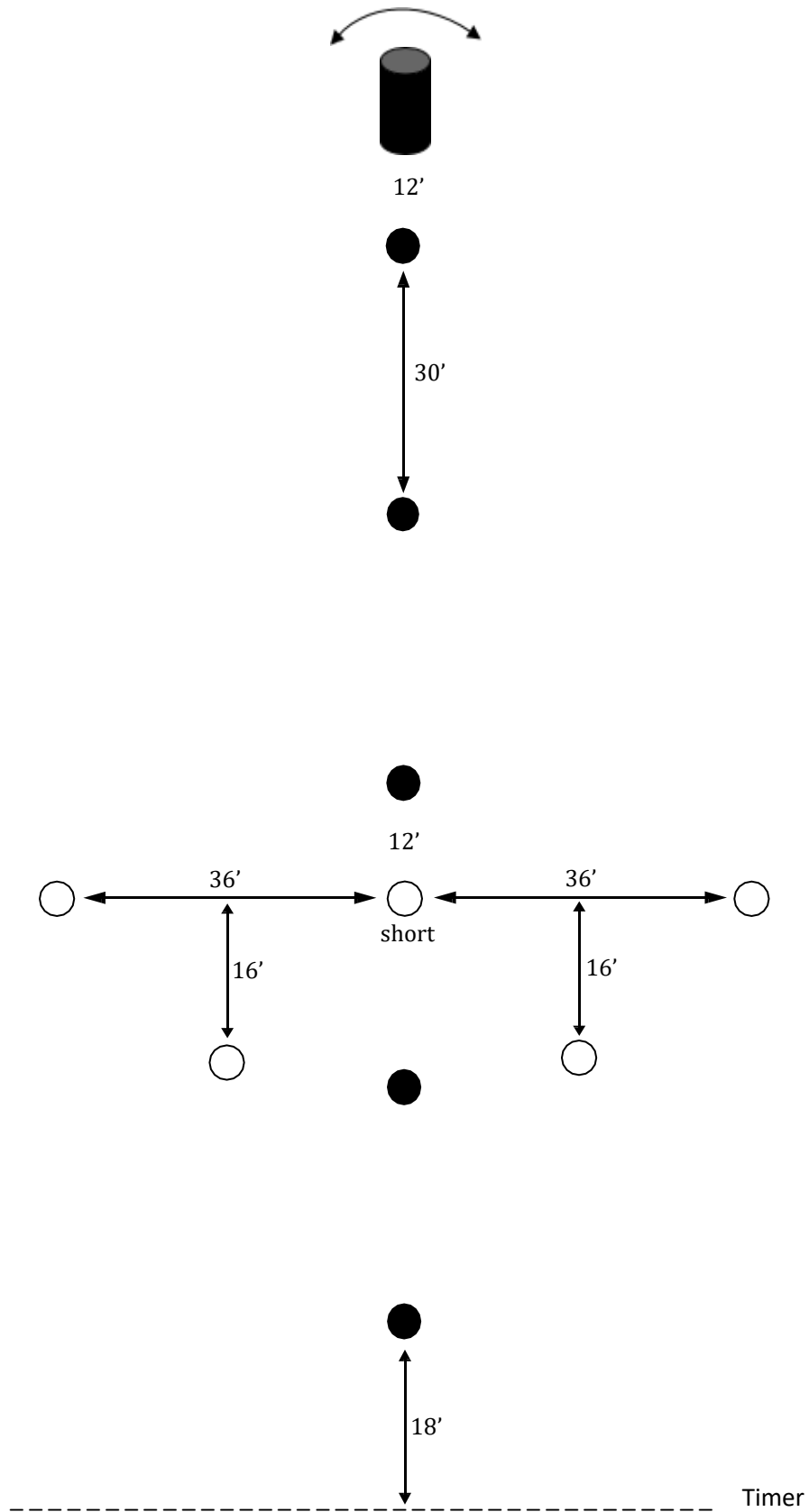

#61

Engage all light targets first. Round the Rundown barrel, then engage the dark targets.

Procedurals: 1,3

Shotgun/Rifle

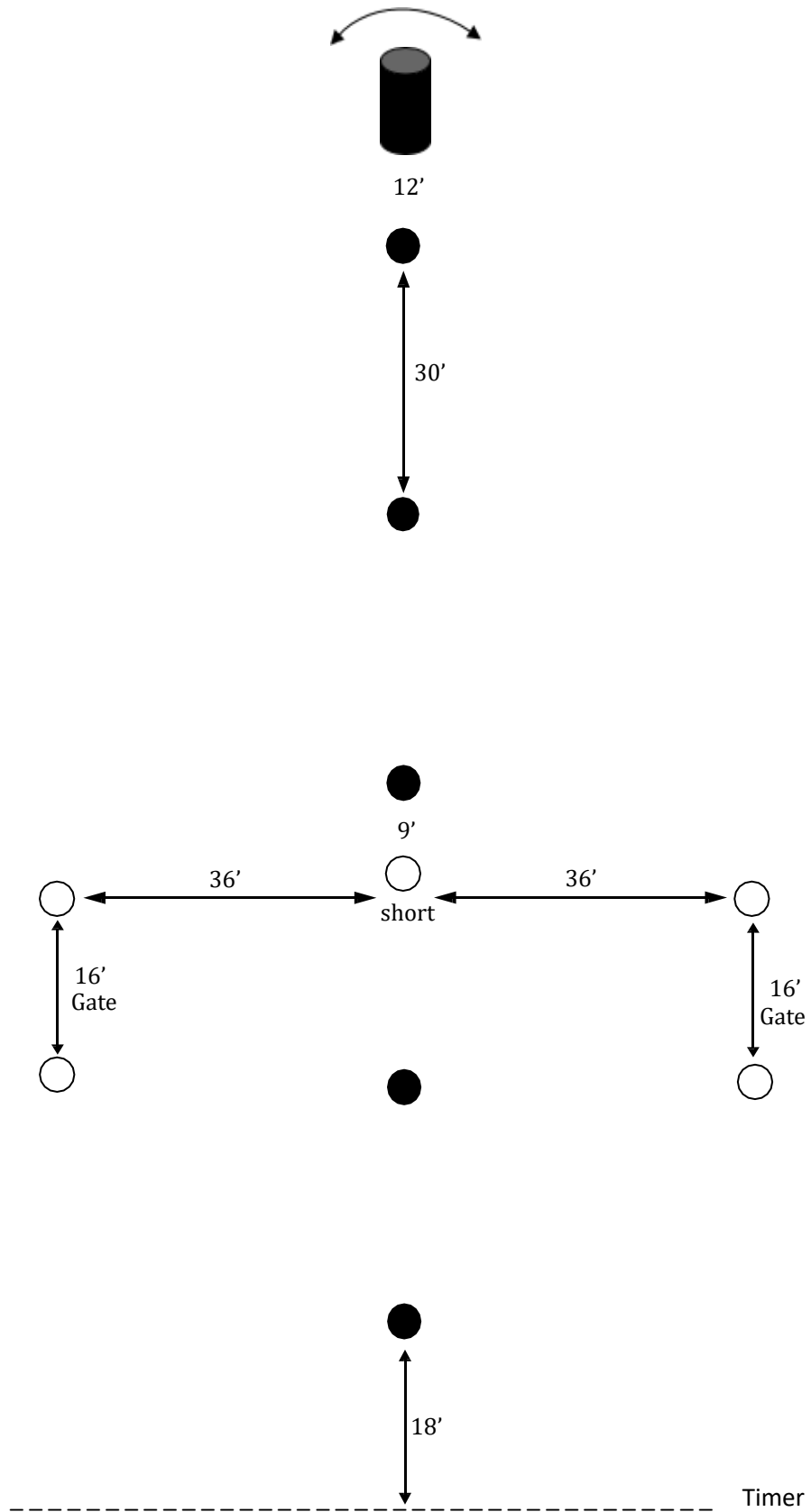

#62

Engage all light targets first. Round the Rundown barrel, then engage the dark targets.

Procedurals: 1,2,3

Shotgun/Rifle

© 2022

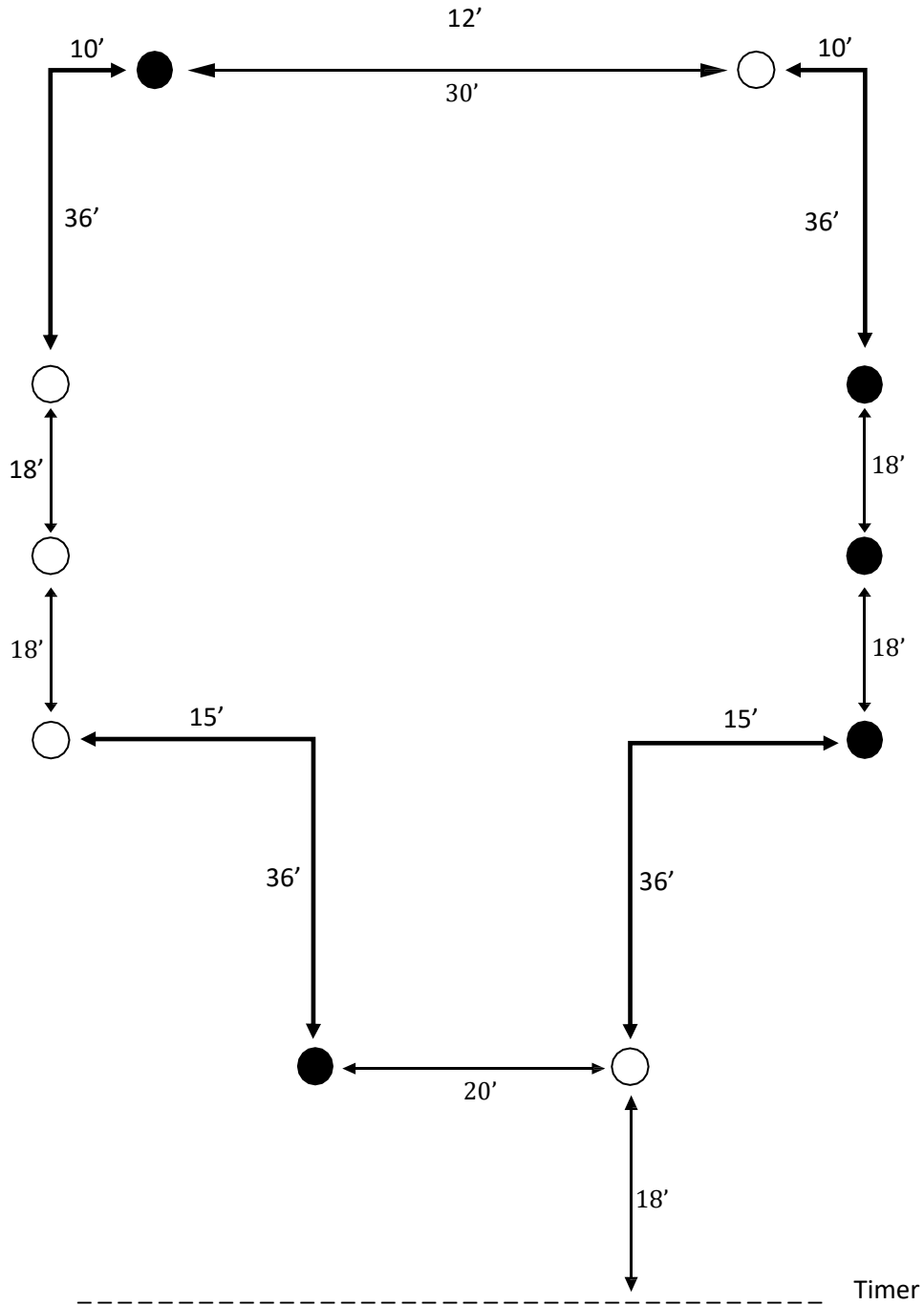
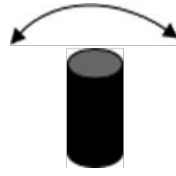

#63

Engage 5 of one color, then engage 5 of the other color.

Procedurals: 1,3, 4

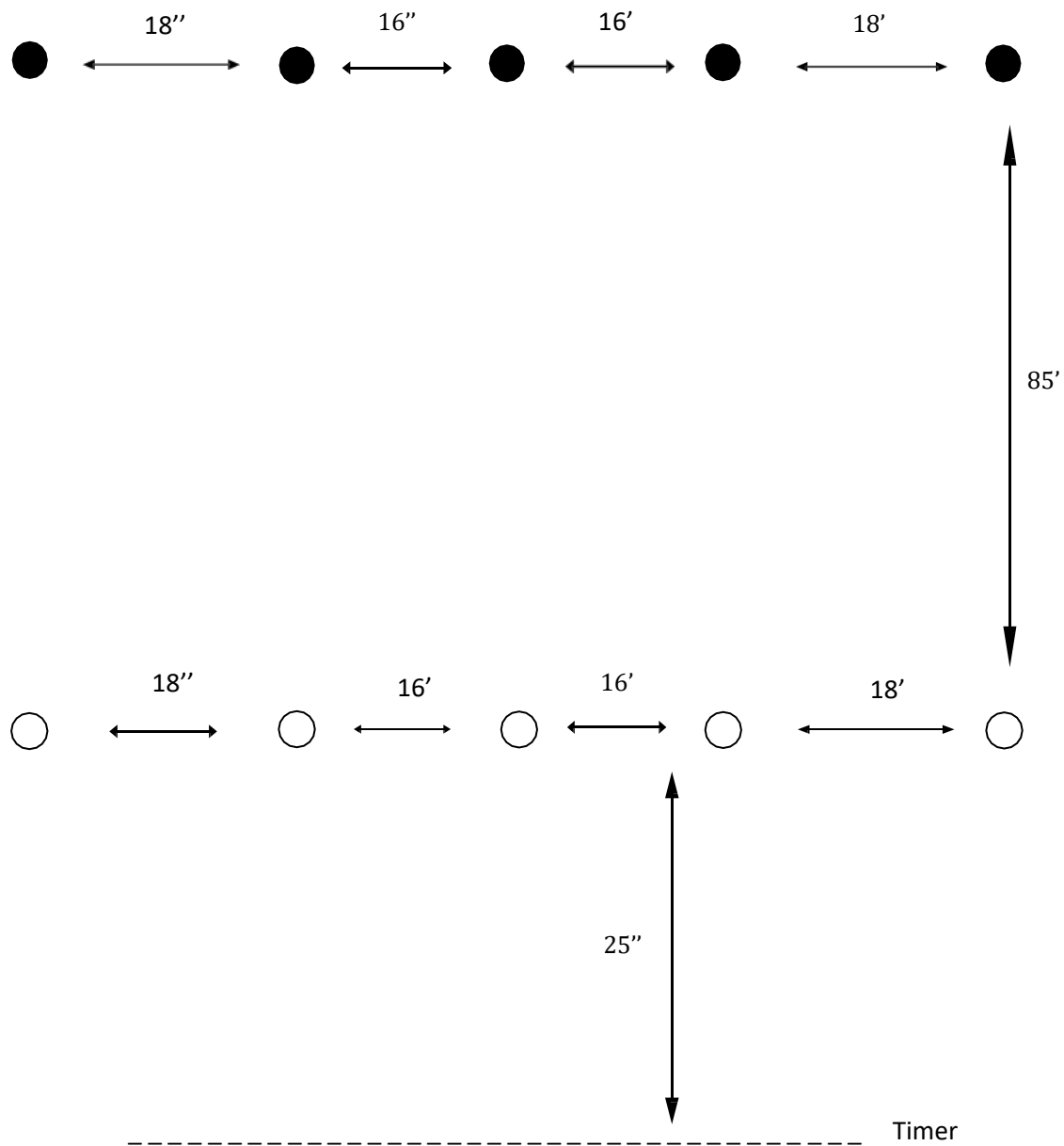

Engage 5 of one color, then engage 5 of the other color.

Procedurals: 3, 4

#64

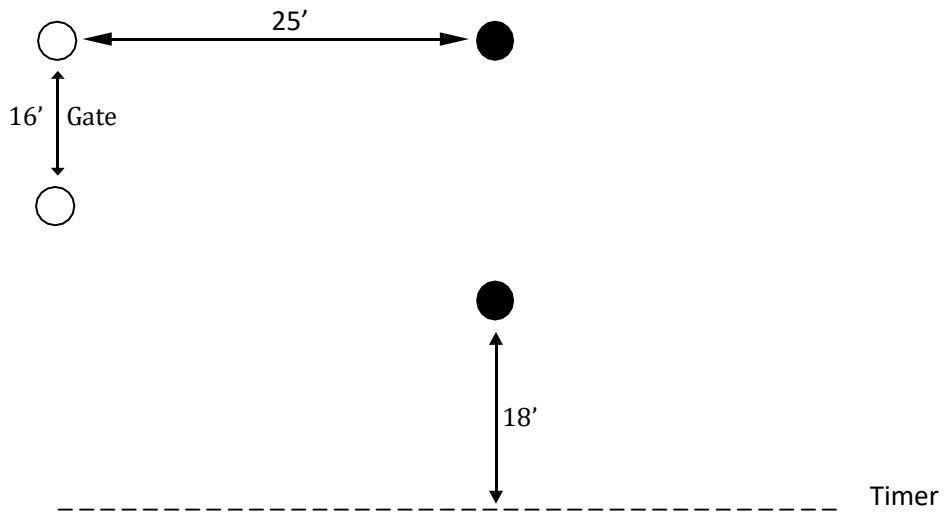
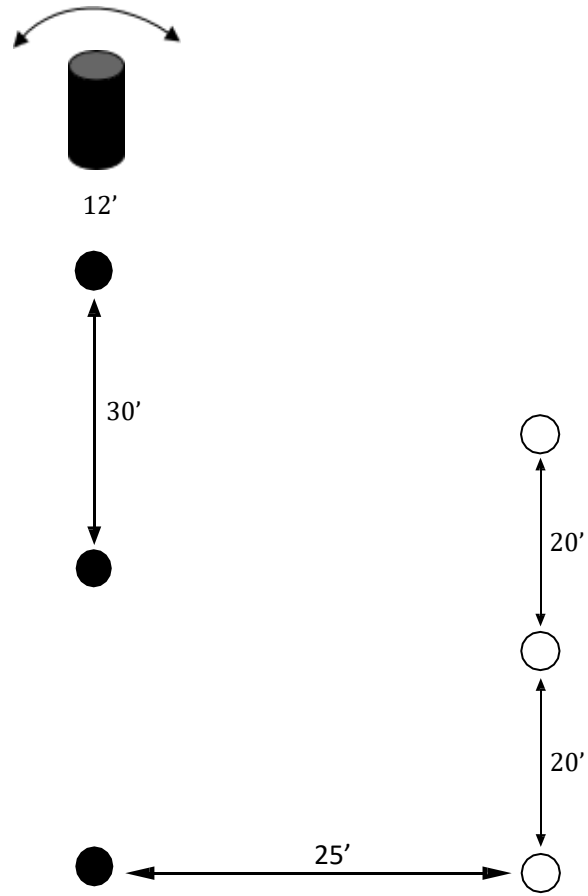

#65

Engage all light targets first. Round the Rundown barrel, then engage the dark targets.

Procedurals: 1,2,3,4

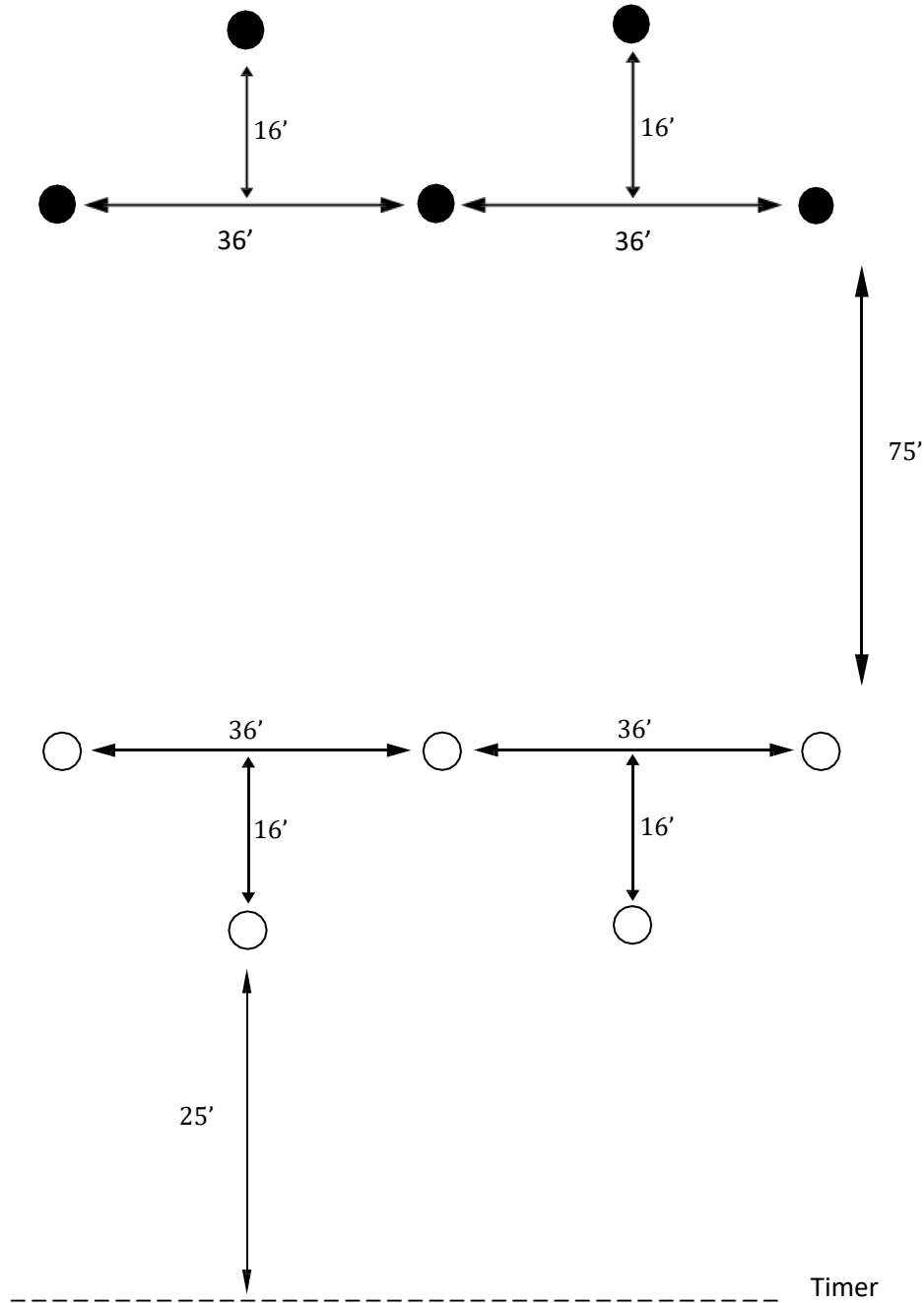

Engage 5 of one color, then engage 5 of the other color.

Procedurals: 3,4

#66

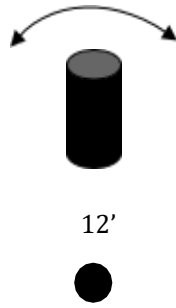

12'

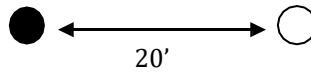

20'

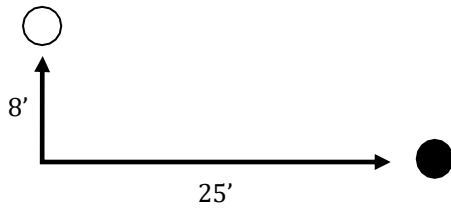

8'

25'

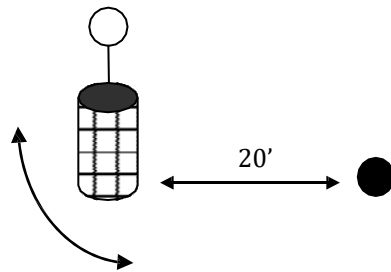

20'

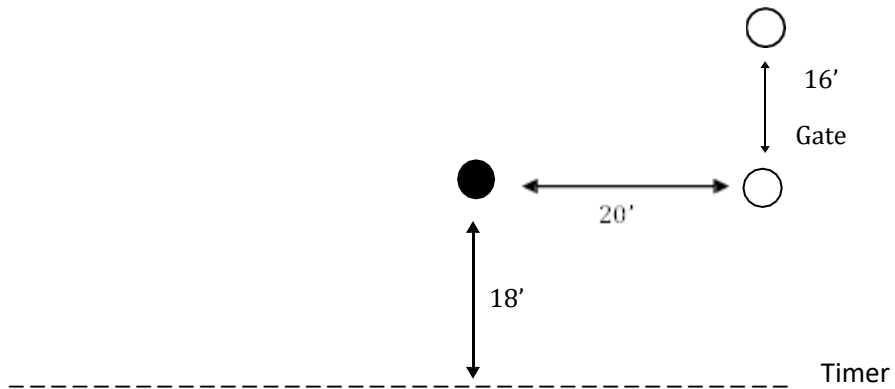

16'

Gate

20'

18'

Timer

#67

Engage the random course first. Round the Rundown barrel, then engage the dark targets.

Procedurals: 1,3

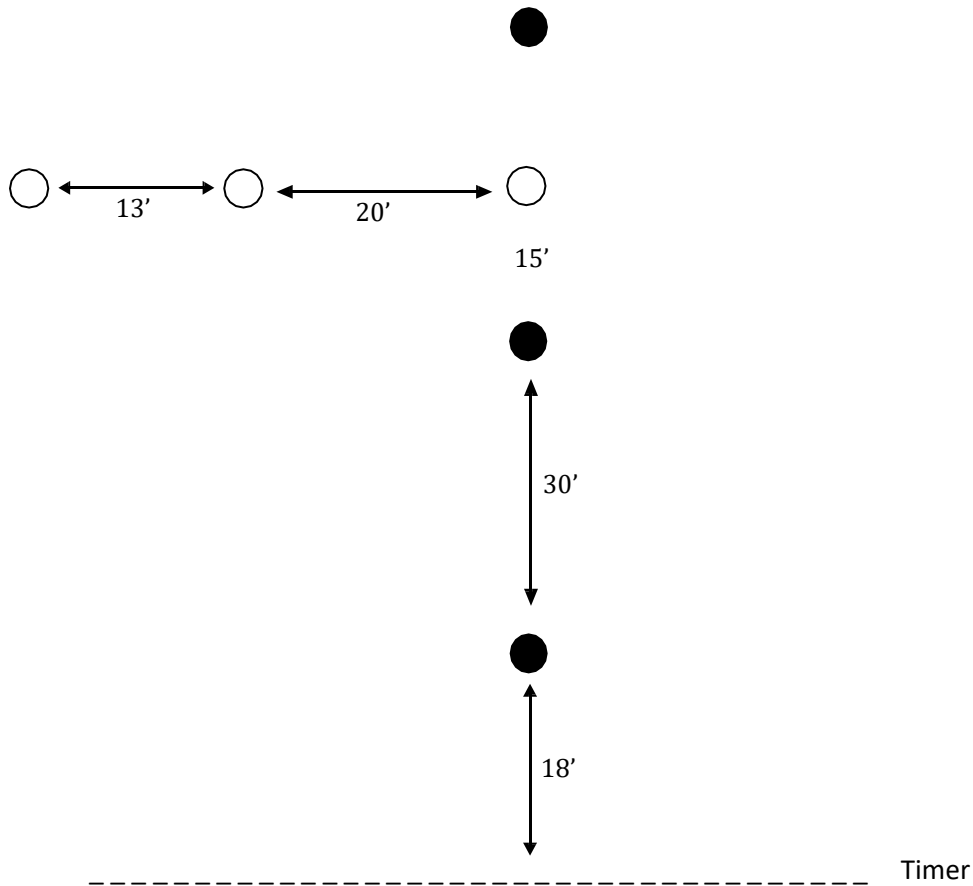
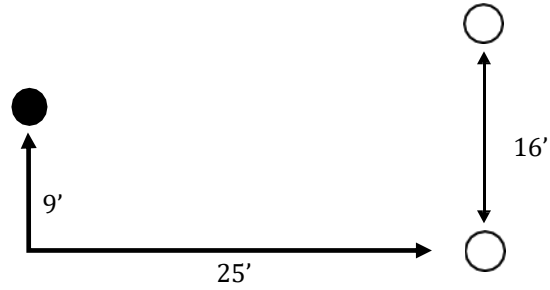
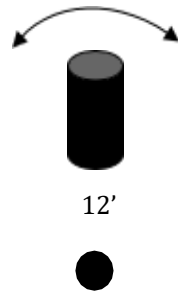

#68

Engage all light targets first. Round the Rundown barrel, then engage the dark targets.

Procedurals: 1,2,3

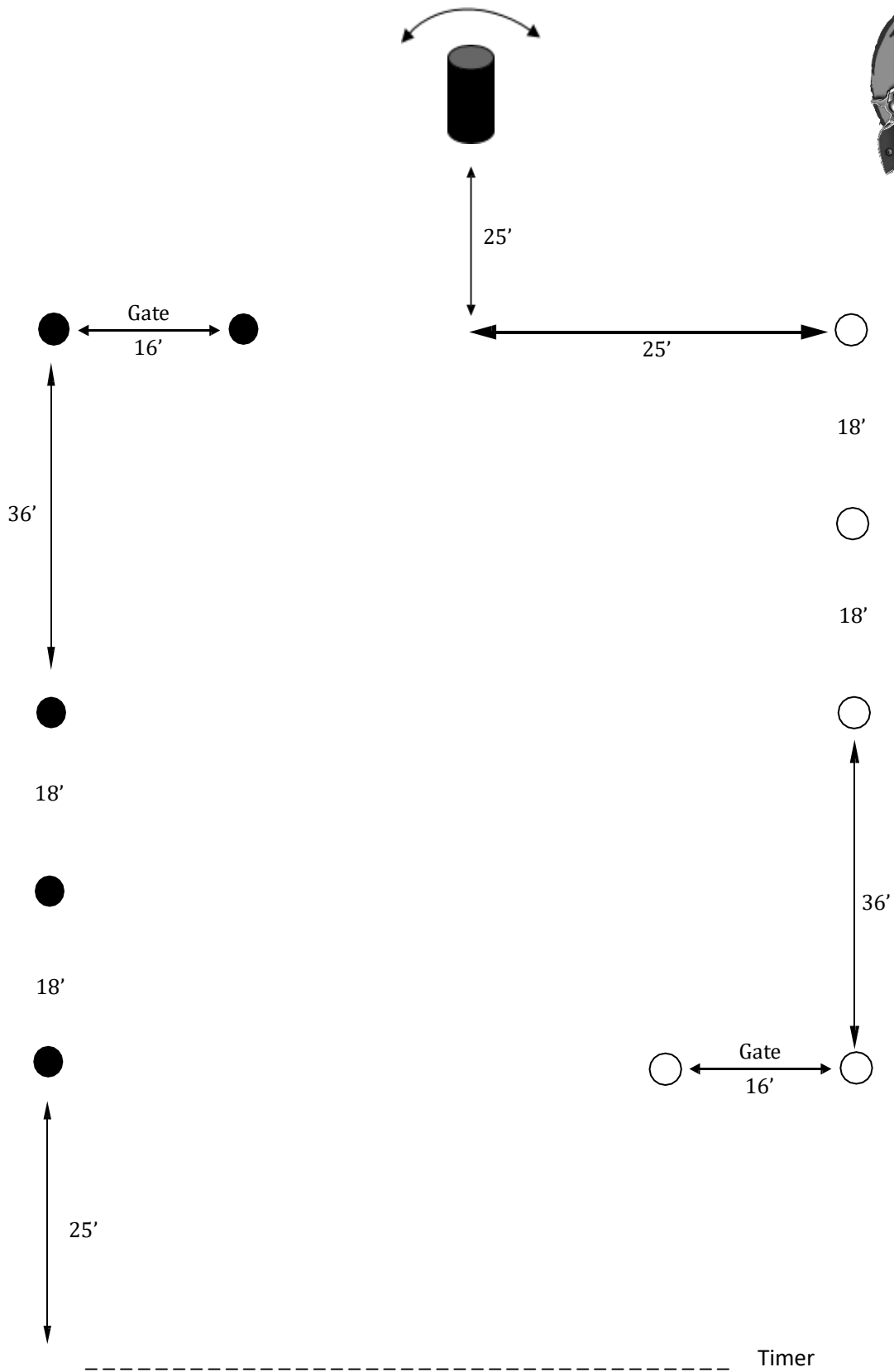

#69

Engage one color of targets. Round the Rundown barrel, then engage the other color of targets.

Procedurals: 1,2,3

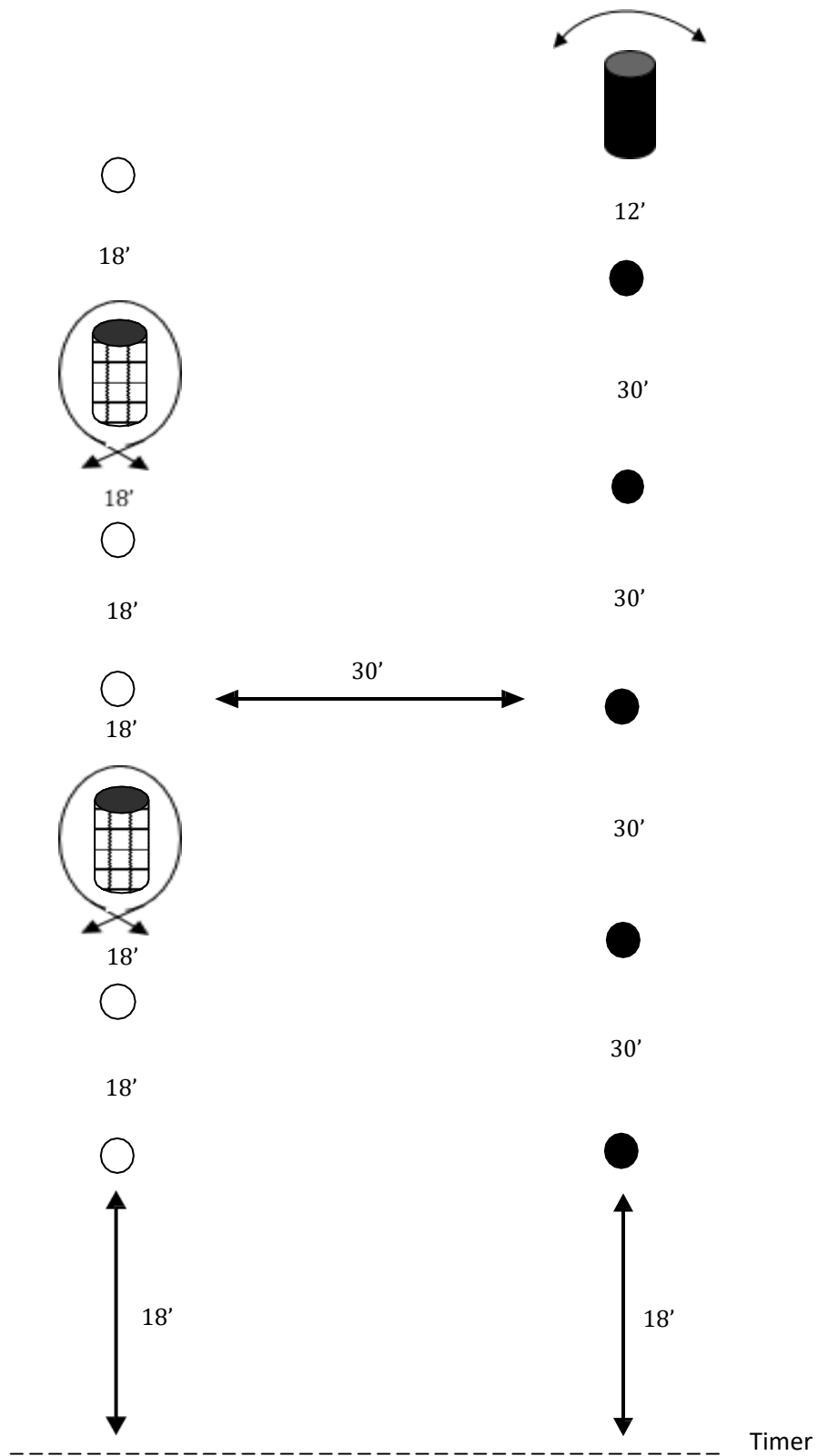

#70

Engage 5 of one color, round the Rundown barrel, then engage 5 of the other color.

Procedurals: 1,3

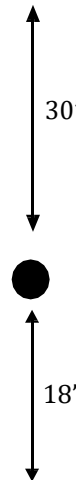
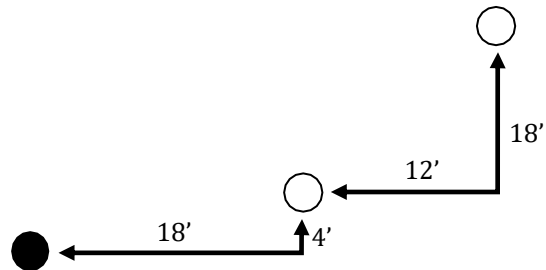
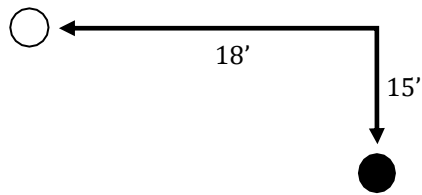
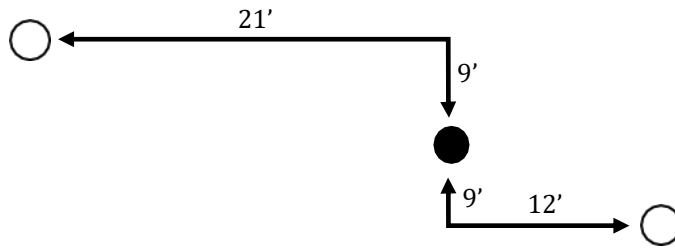
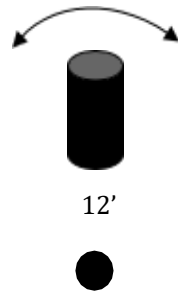

----- Timer

#71

Engage all light targets first. Round the Rundown barrel, then engage the dark targets.

Procedurals: 1,3

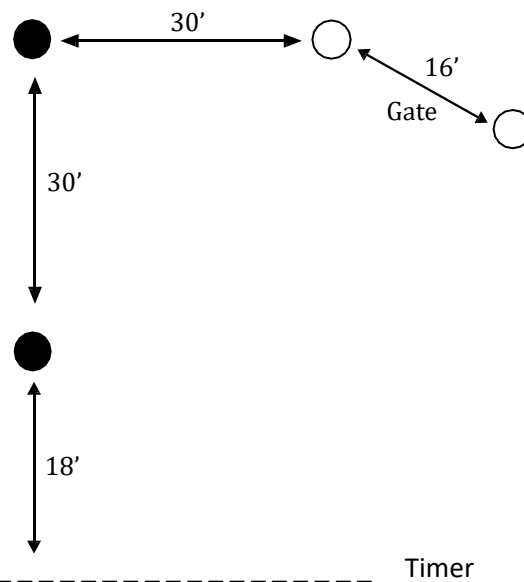
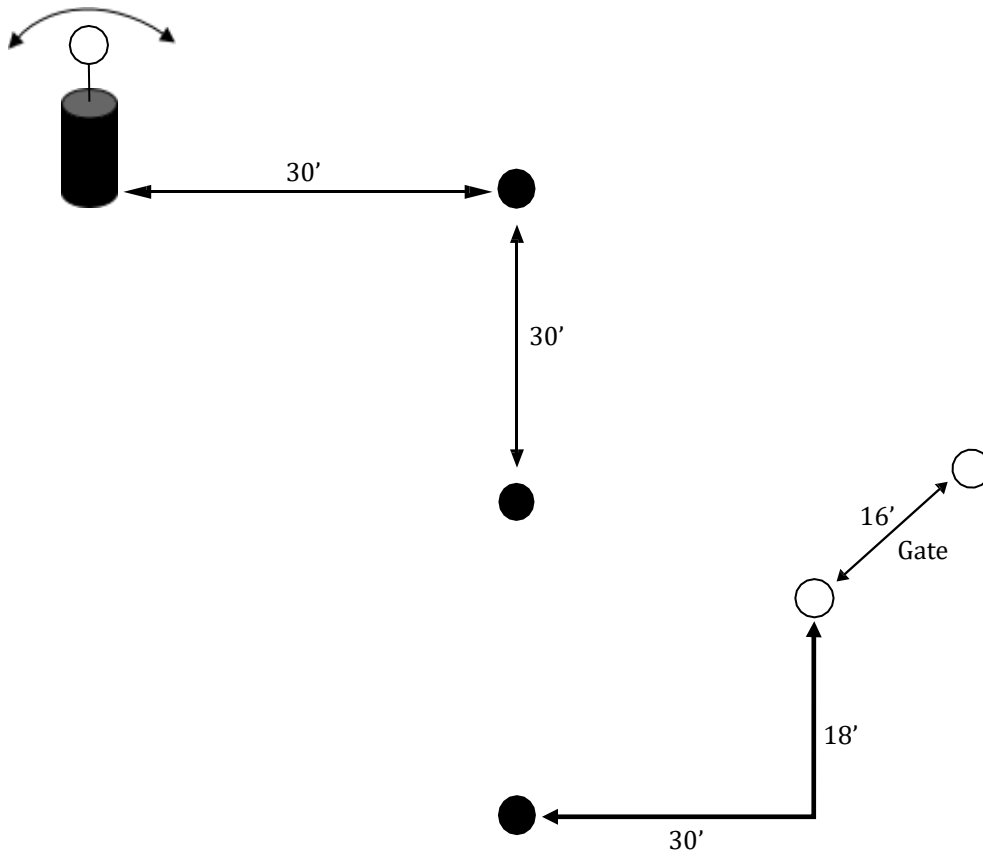

#72

Engage all light targets first. Round the Rundown barrel, then engage the dark targets.

Procedurals: 1,2,3

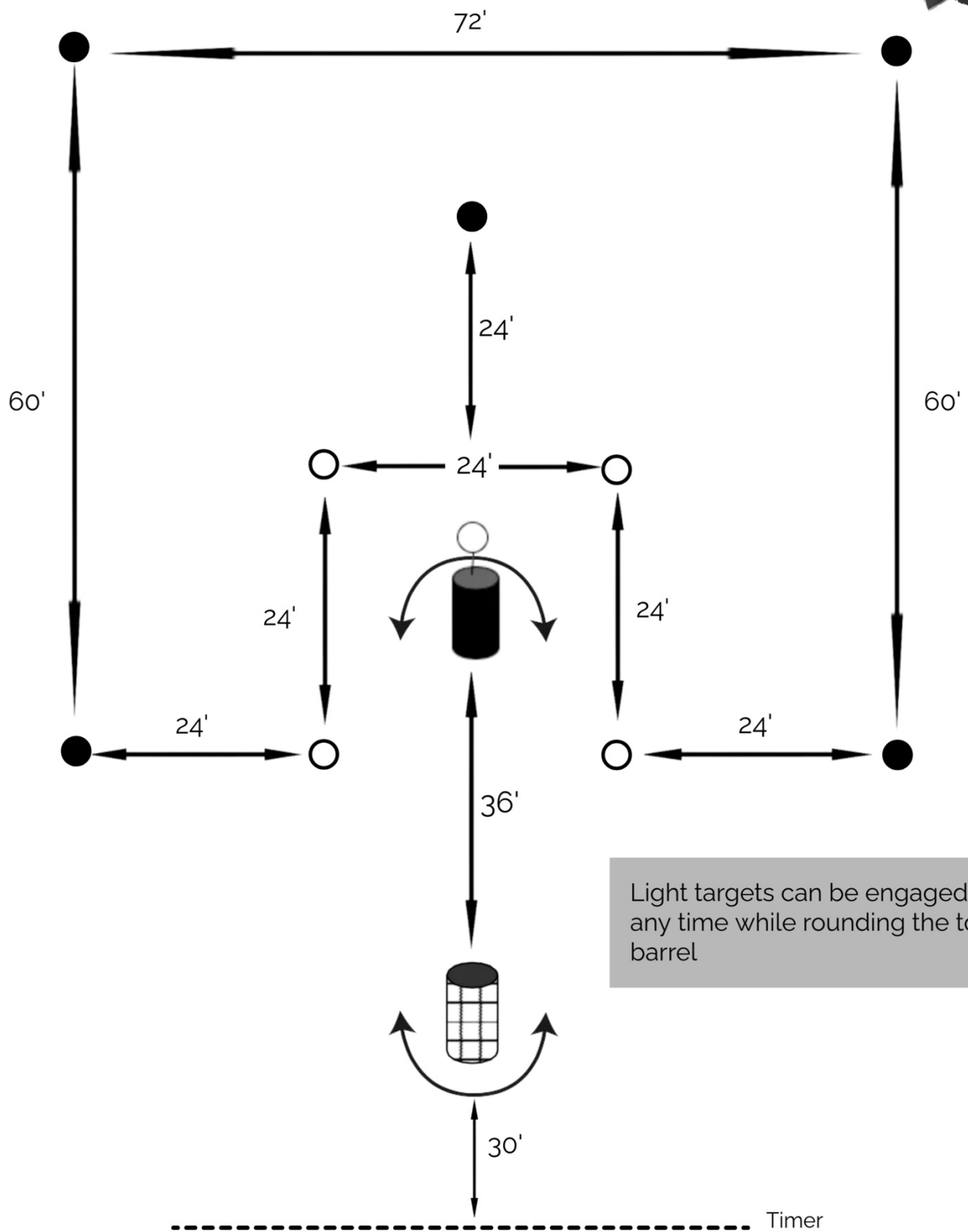

Engage all light targets first. Round the bottom barrel, then engage dark targets

Procedurals: 1,3

#73

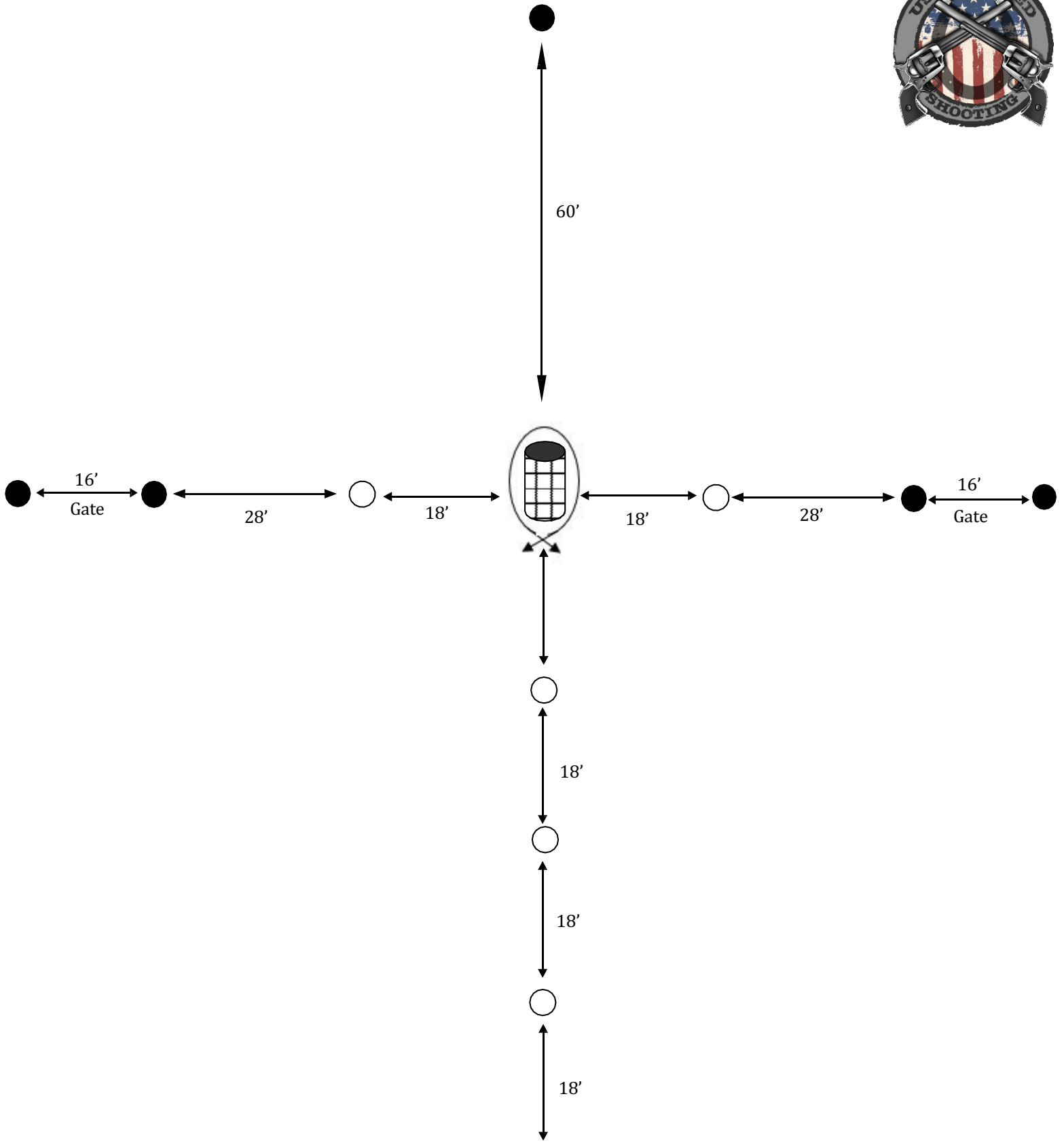

----- Timer

#74

Engage all light targets first. Round the barrel, then engage the dark targets.

Procedurals: 1, 2, 3, 5

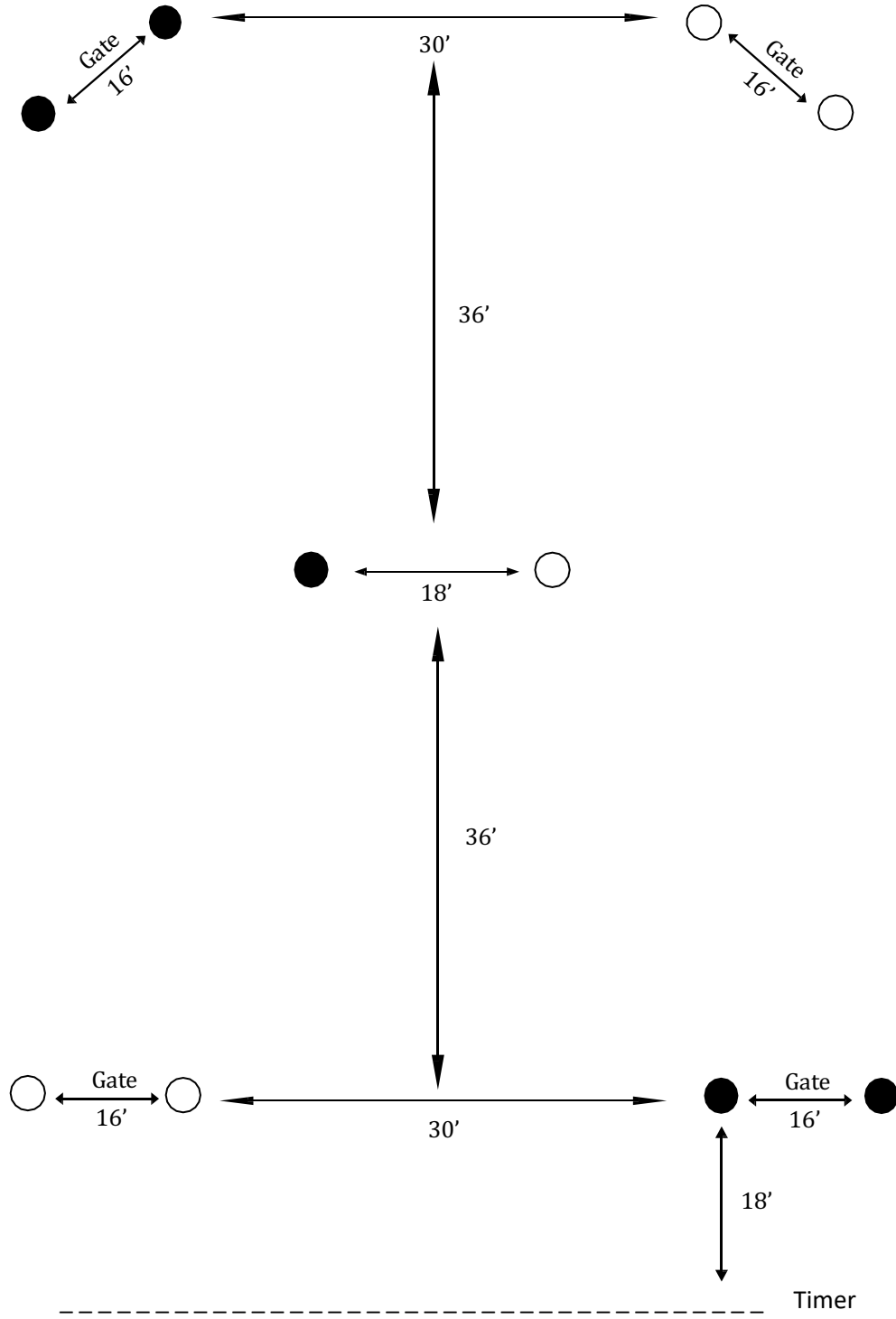

#75

Engage one color of targets, then engage the other color of targets.

Procedurals: 2,3

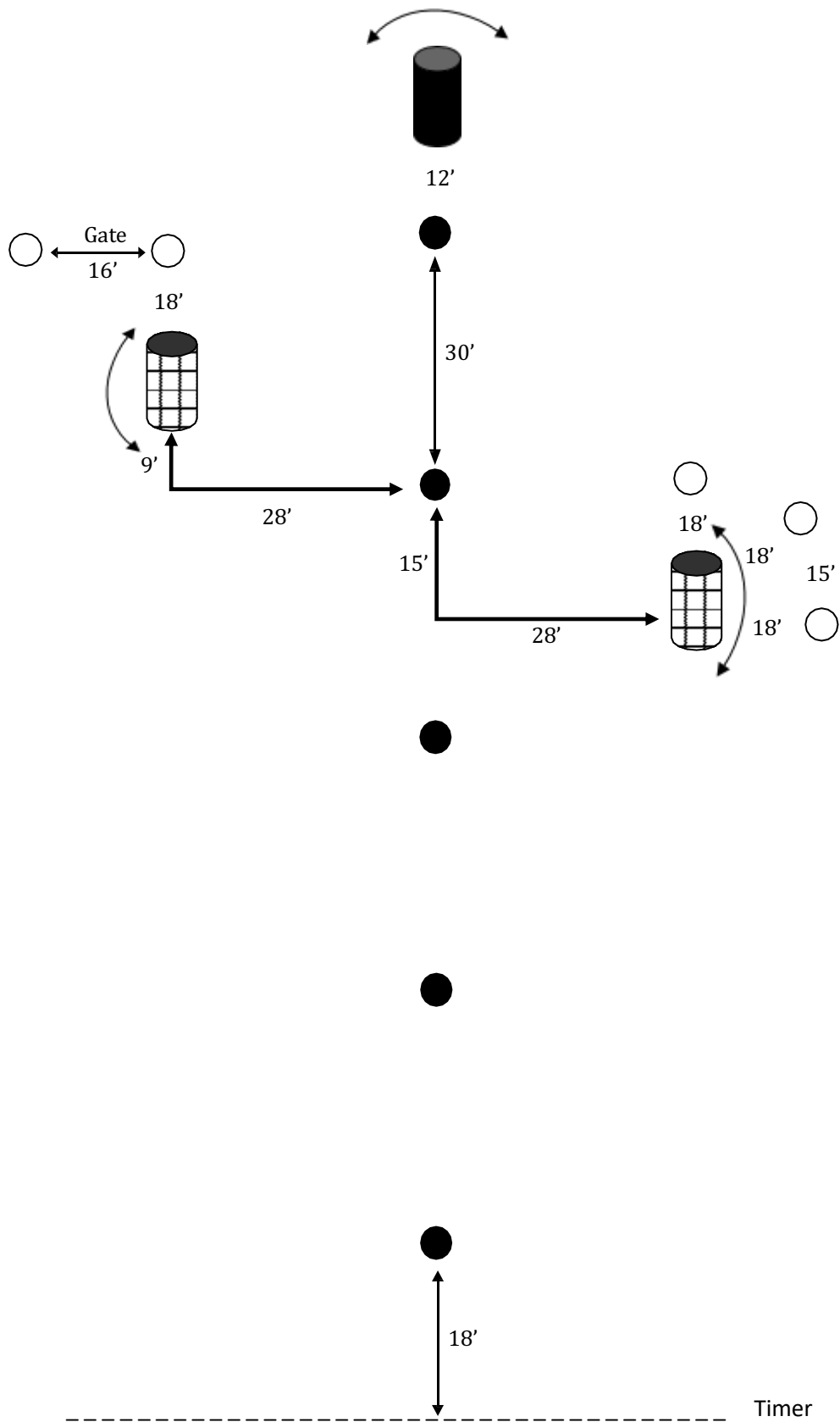

#77

Engage the random course first. Round the Rundown barrel, then engage the dark targets.

Procedurals: 1,2,3,5

TOB – Target on top of
Barrel – May be shot
coming into or leaving the
turn

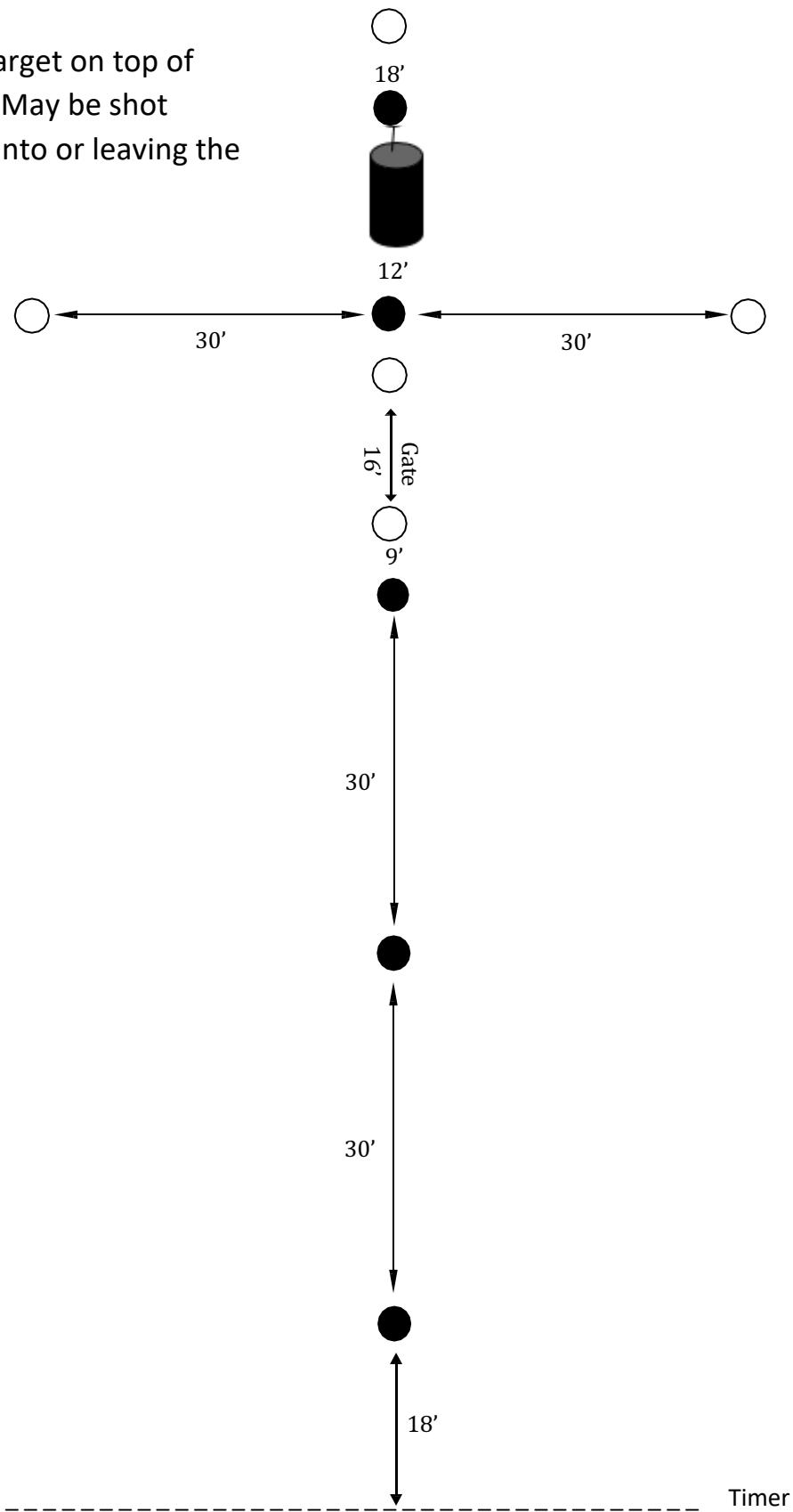

#78

Engage the entire random course first. Round the rundown barrel, then engage dark targets. (Target on top of barrel may be shot coming into or leaving the turn).

Procedurals: 1,2,3,5

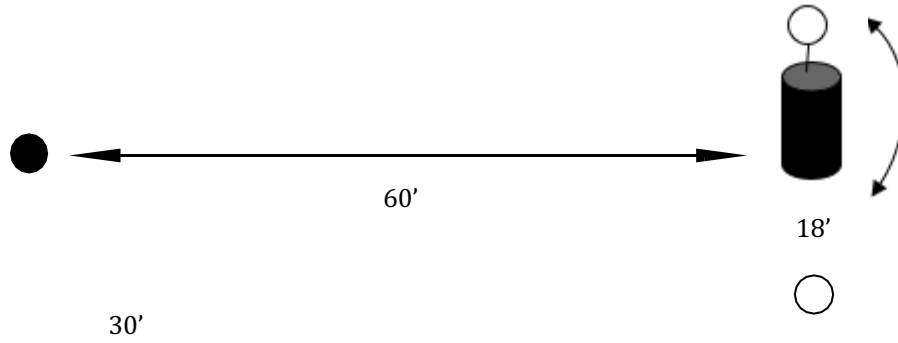

#80

Engage the random course first. Round the Rundown barrel, then engage the dark targets.

Procedurals: 1,2,3,5



**ENGAGE TOP 2
TARGETS FIRST**

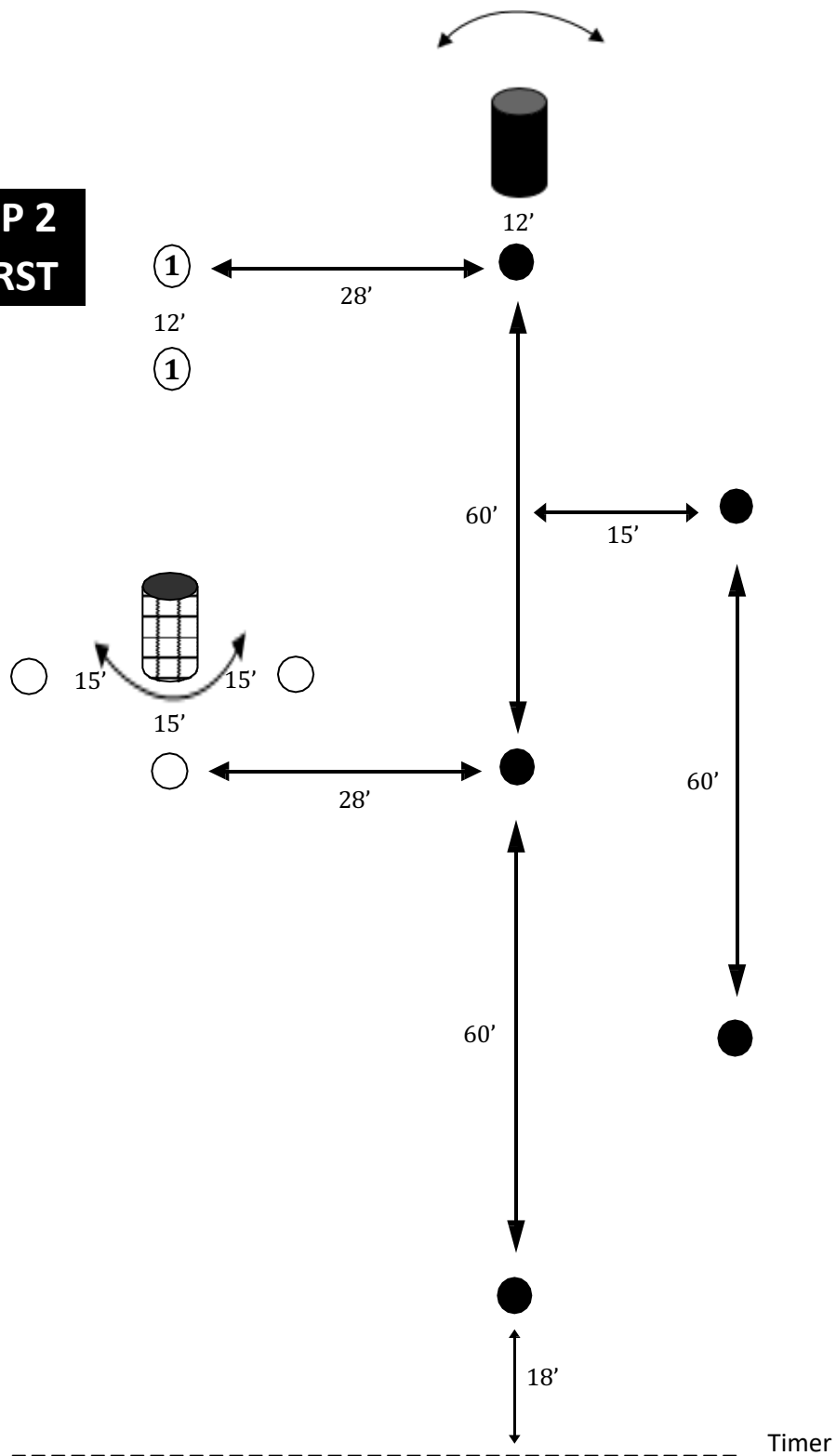

#81

Engage light 2 targets first. Round the random barrel while engaging the remaining targets. Then round the rundown barrel, engage dark targets.

Procedurals: 1,3,4,5

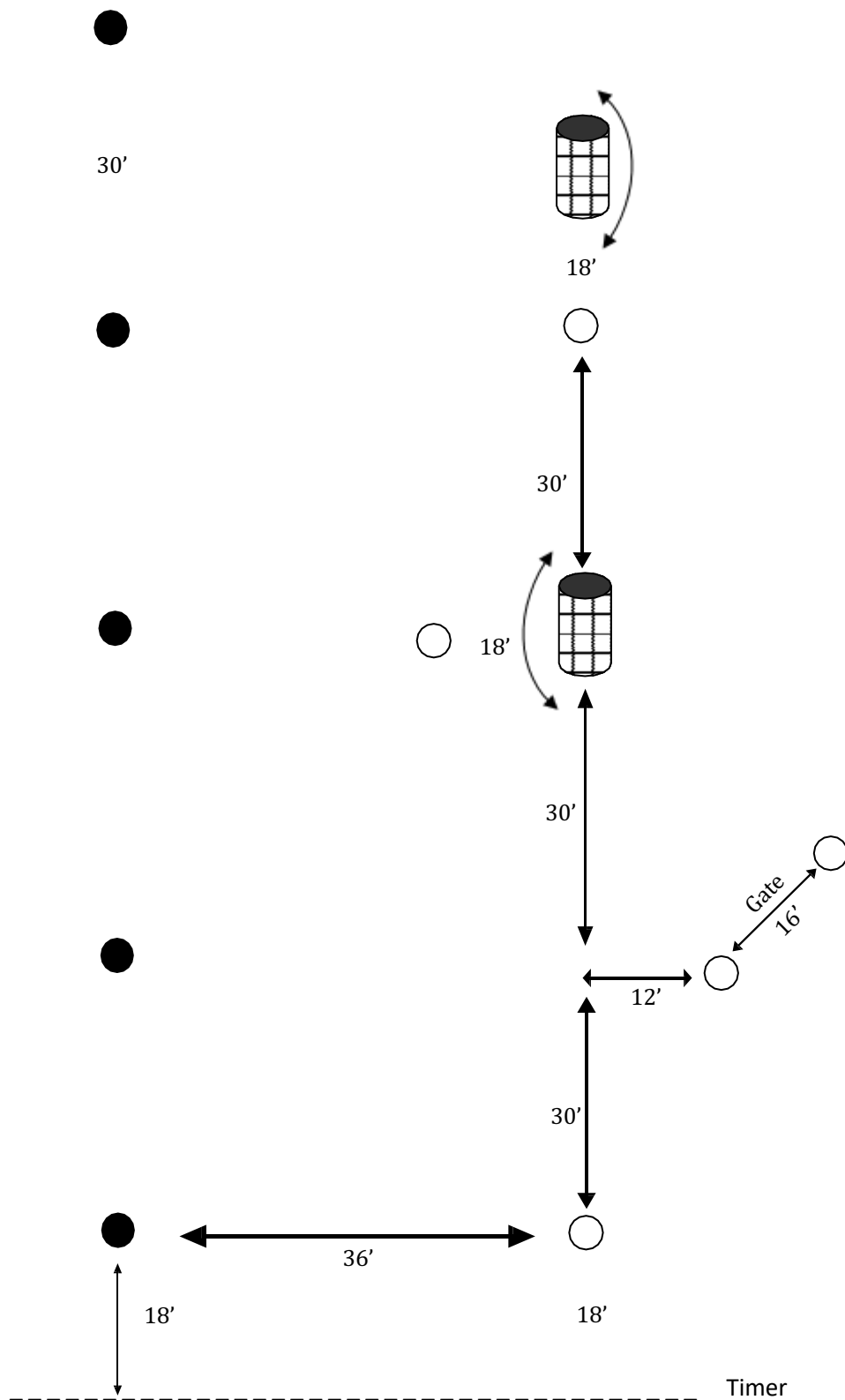

Engage the random course first. Then engage the dark targets.

Procedurals: 1,2,3,5

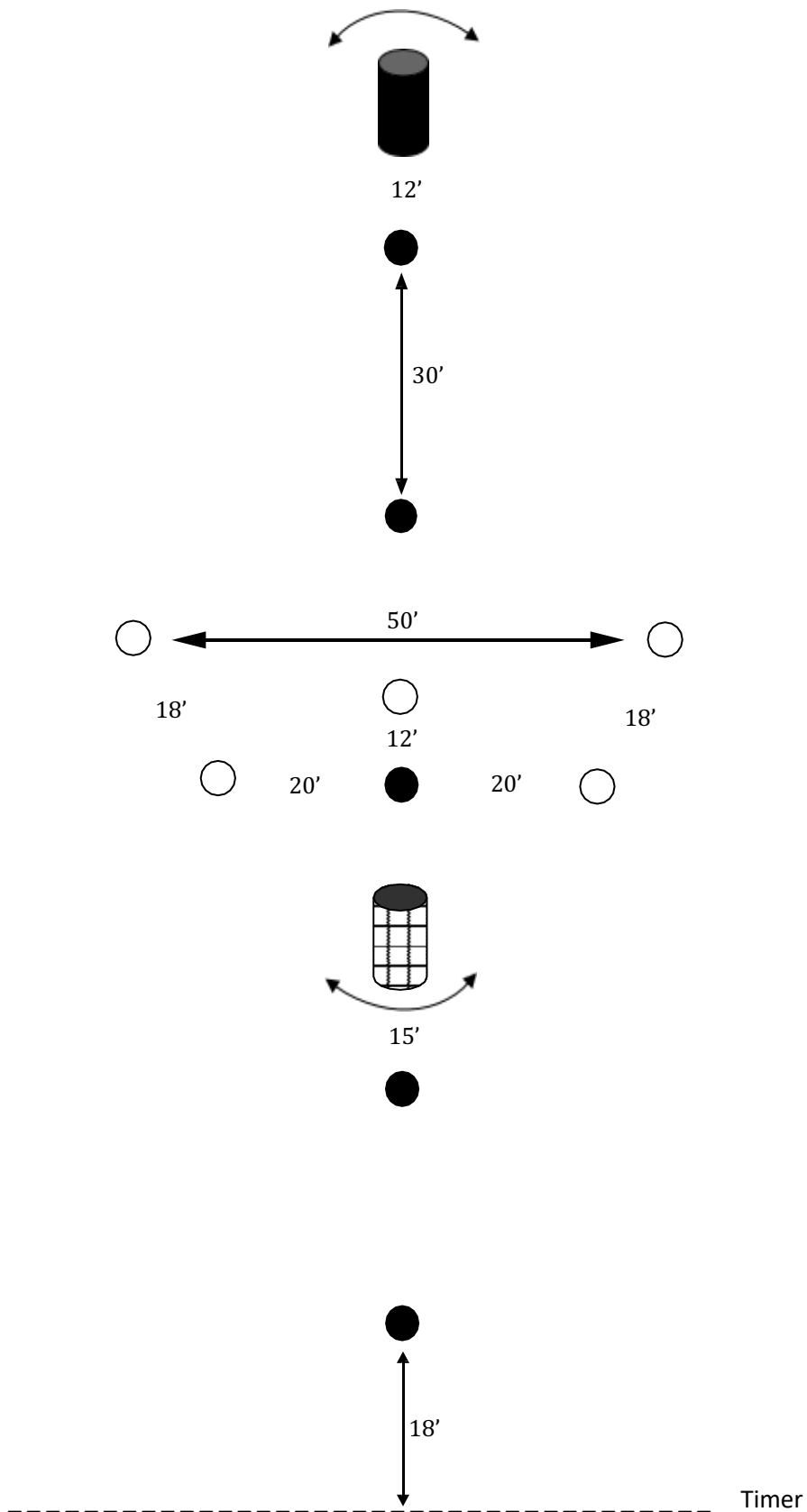

#83

Engage the random course first. Round the Rundown barrel, then engage the dark targets.

Procedurals: 1,3,5

Shotgun/Rifle

© 2022

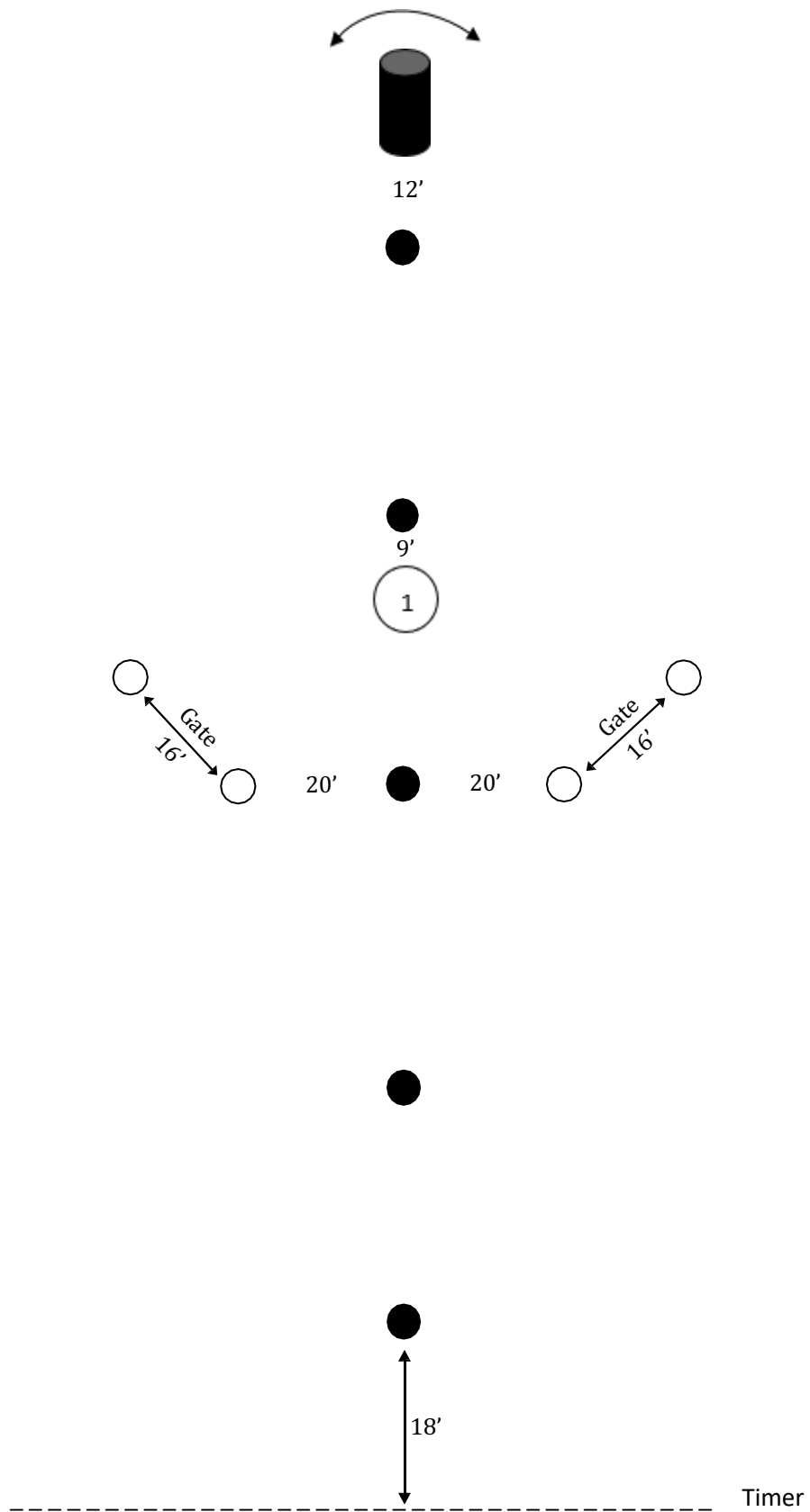

#84

Engage target 1 first, then engage the random course. Round the Rundown barrel, then engage the dark

Procedurals: 1,2,3,4,5

Shotgun/Rifle

© 2022

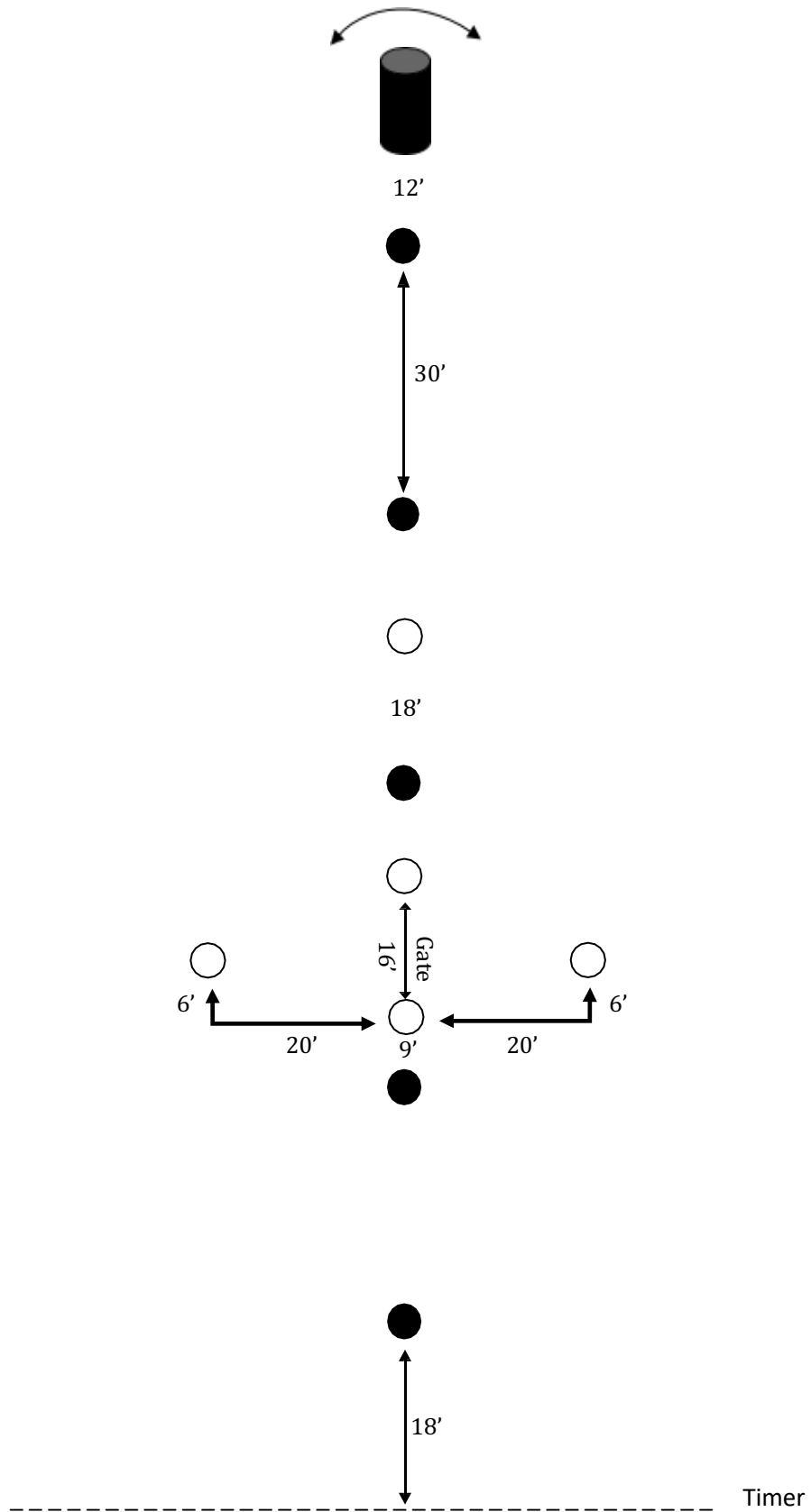

#85

Engage the random course first. Round the Rundown barrel, then engage the dark targets.

Procedurals: 1,2,3,5

Shotgun/Rifle

© 2022

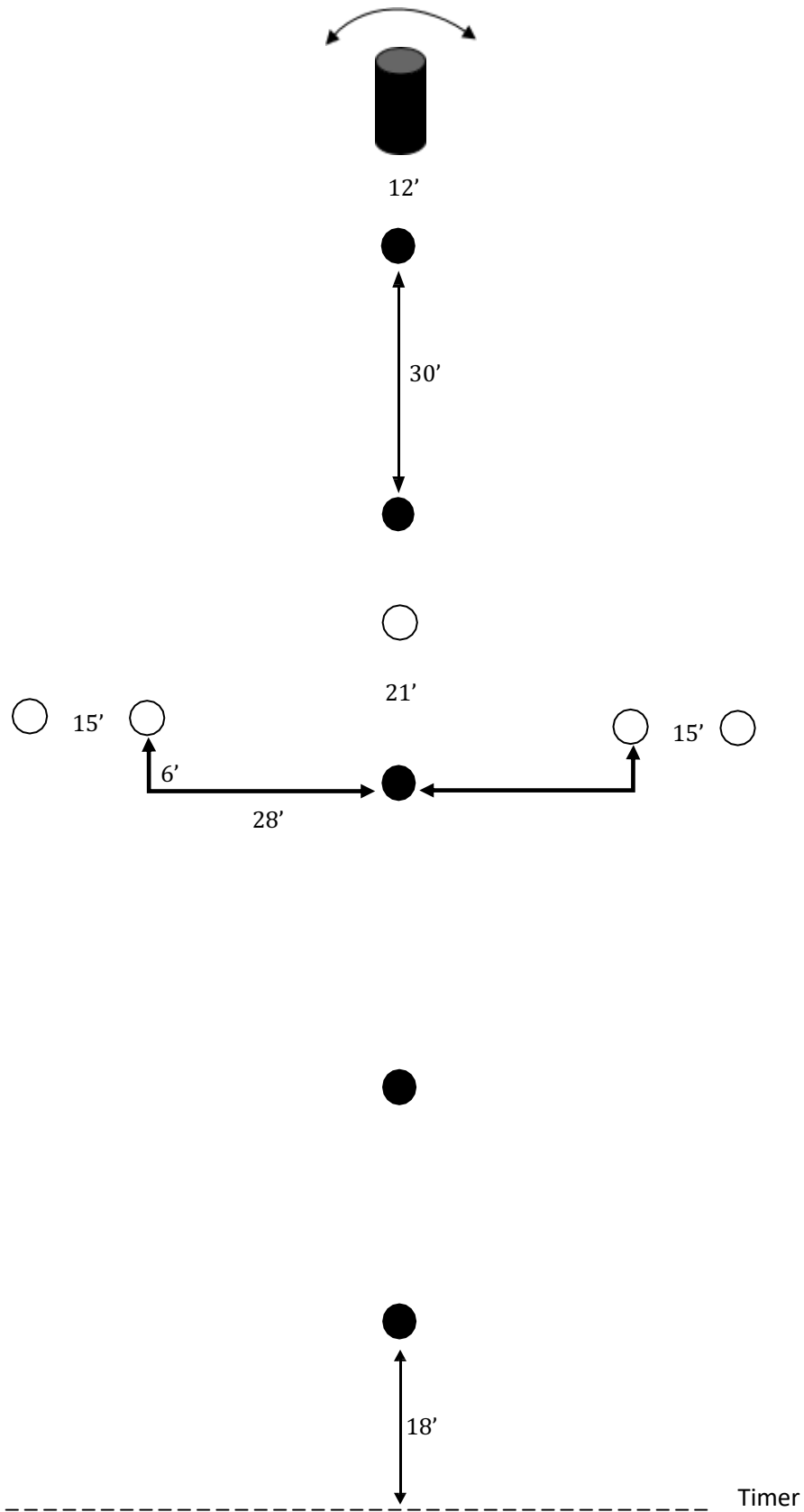

#86

Engage the random course first. Round the Rundown barrel, then engage the dark targets.

Procedurals: 1,2,3,5

Shotgun/Rifle

© 2022

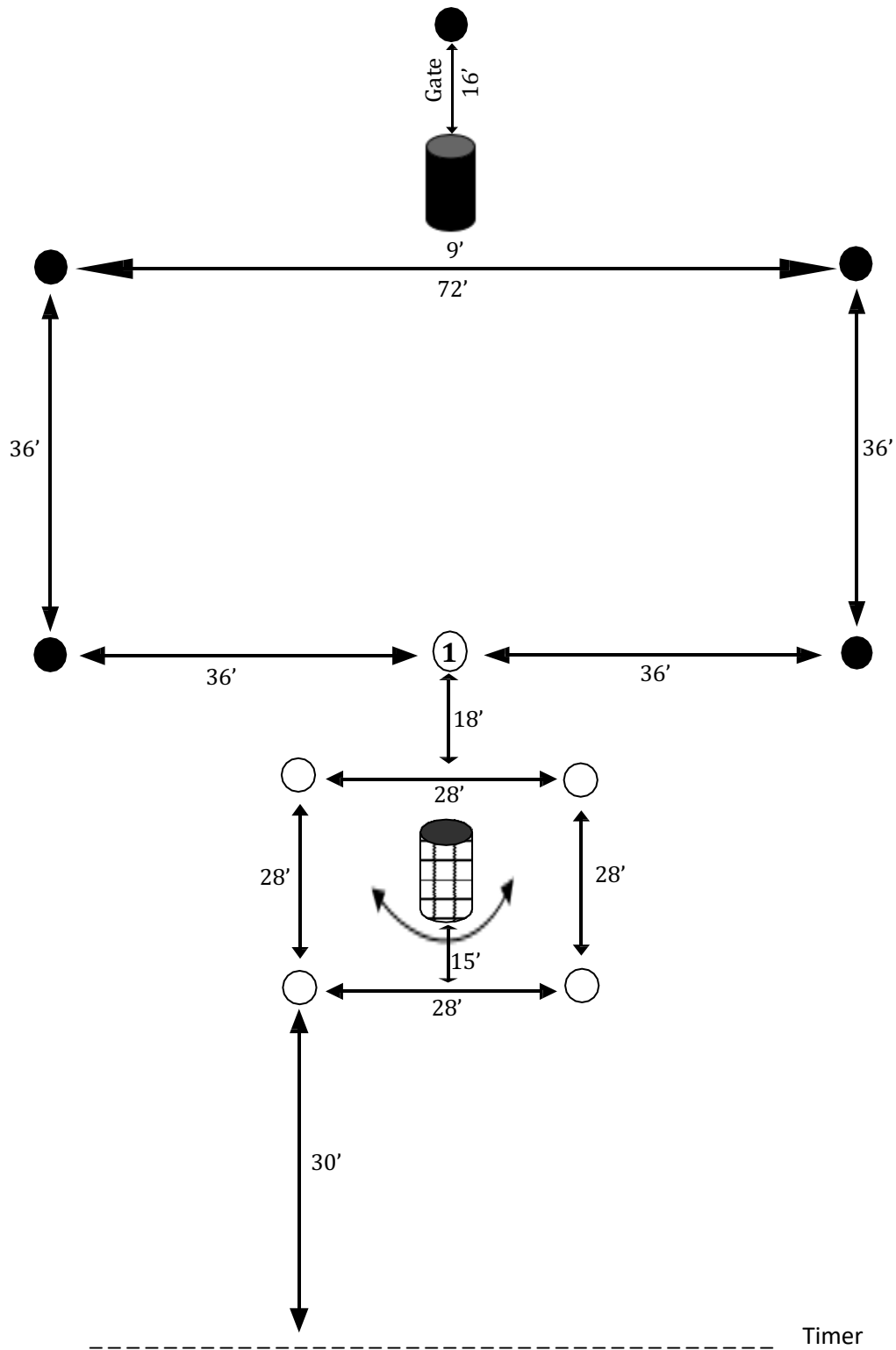

#87

Engage light target #1 First, then engage the entire random course. Then engage dark targets.

Procedurals: 1,2,3,4,5

© 2022